

REA Office

montážny návod

S50

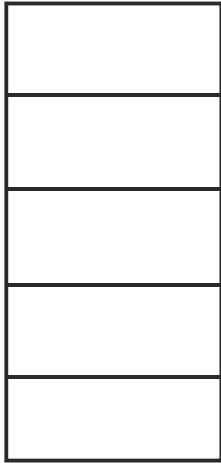

S50+D5 (2ks)

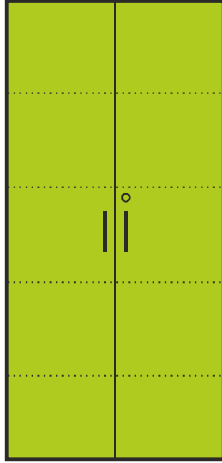

S50+D3(2ks)

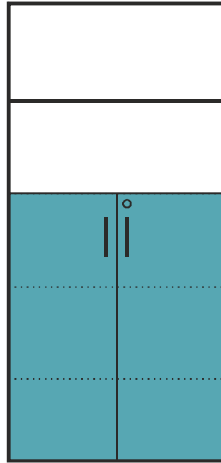

S50+D2(2ks)

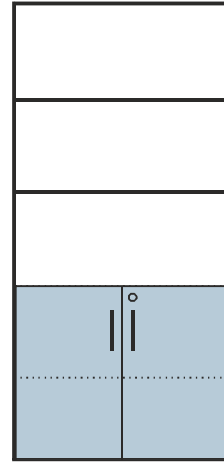

S30(2ks)

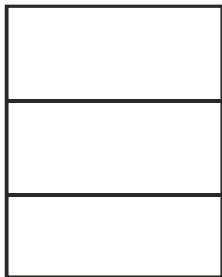

S30+D3(2ks)

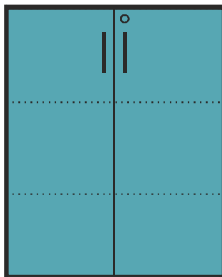

S30+D2(2ks)

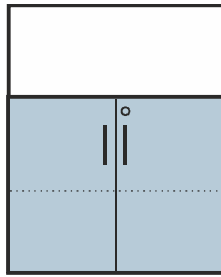

S20

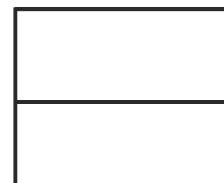

S20+D2(2ks)

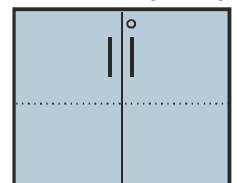

50



50+D5
(1ks)

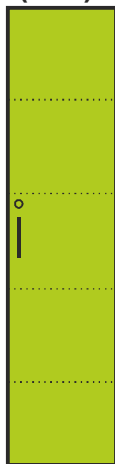

50+D3
(1ks)

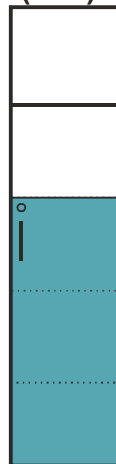

50+D2
(1ks)

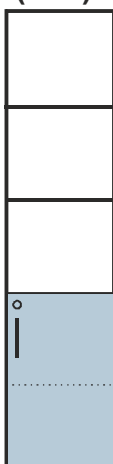

30



30+D3
(1ks)



30+D2
(1ks)

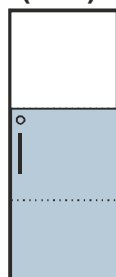

20

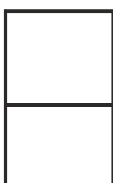

20+D2
(1ks)

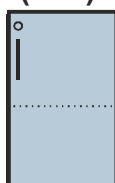













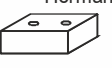







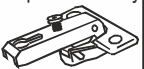

Všeobecné informácie

- Balenie
 - Pri rozbaľovaní nepoužívajte ostré predmety, zabránite tak poškodeniu jednotlivých častí nábytku.
 - Skontrolujte obsah všetkých častí podľa montážneho návodu.
- Montáž
 - Montáž nábytku vykonávajte vždy na pevnej a čistej podložke, predídete tak možnému poškodeniu podlahy a nábytku.
 - Montáž vykonávajte postupne podľa priloženého montážneho návodu a dbajte na všetky uvedené pokyny.
 - Na samotnú montáž si pripravte potrebné náradie podľa pokynov v montážnom návode, okrem toho montáž by mali vykonávať najmenej 2 osoby.
- Pokyny pre správne umiestnenie a dôležité upozornenia
 - Nábytok používať iba v súlade s jeho určením.
 - Pri priamom slnečnom žiarení hrozí zosvetlenie farieb, hlavne pri čalúnených prvkoch nábytku.
 - Neumiestňujte nábytok v blízkosti vykurovacích telies.
 - Neumiestňujte nábytok tam, kde je vyššia vlhkosť prostredia. Materiály by mohli vplyvom vlhkosti stratiť svoju stabilitu a kvalitu.
 - Nábytok presúvajte iba uchopením a nadvihnutím za spodný rám, nikdy ho neťahajte po podlahe.
 - Pri umiestnení nábytku na plávajúcu podlahu odporúčame podložiť nábytok filcovými podložkami.
- Pokyny k údržbe laminovanej alebo fóliovanej drevotriesky
 - Najideálnejšie používať iba mäkkú navlhčenú utierku a po zotrení čo najskôr úplne vysušiť.
 - pri tomto type materiálu môže vplyv vlhkosti nenávratne poškodiť nábytok.
 - Mastnotu je možné odstrániť malým množstvom kuchynského saponátu, ktorý nepôsobí agresívne.
 - Nepoužívajte drsné leštiace pomôcky ani žiadne prchavé chemické latky.

Ďakujeme za prejavenu dôveru a kúpu nášho nábytku.
Veríme že náš výrobok Vám bude slúžiť k plnej spokojnosti.

avaks
nábytok

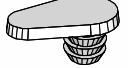
Korpus	20	S20	30	S30	50	S50
1 kolík 8x35 	12ks	12ks	12ks	12ks	12ks	12ks
3 tiaho 	8ks	8ks	8ks	8ks	8ks	8ks
5 excenter 	8ks	8ks	8ks	8ks	8ks	8ks
6 krytka exc. 	8ks	8ks	8ks	8ks	8ks	8ks
10 klzák Herman 	4ks	4ks	4ks	4ks	4ks	4ks
18 skrutka ZH 5x25 	8ks	8ks	8ks	8ks	8ks	8ks
19 podperka s hrotom 	2ks	2ks	4ks	4ks	8ks	8ks
20 podperka 	2ks	2ks	4ks	4ks	8ks	8ks
21 skrutka ZH 3,5x20 	8ks	8ks	10ks	10ks	14ks	14ks
22 chrbátová spojka 	8ks	8ks	10ks	10ks	14ks	14ks
23 spojovacia skrutka 	2ks	2ks	2ks	2ks	2ks	2ks

Dvere	D2 1ks	D2 2ks	D3 1ks	D3 2ks	D5 1ks	D5 2ks
7 záves polonaložený 	2ks	4ks	2ks	4ks	3ks	6ks
8 podložka závesu 	2ks	4ks	2ks	4ks	3ks	6ks
24 uholník 20/20 	2ks	2ks	2ks	2ks	2ks	2ks
25 skrutka ZH 3,5x16 	8ks	12ks	8ks	12ks	10ks	14ks
26 skrutka ZH 3x20 	4ks	4ks	4ks	4ks	4ks	4ks
27 skrutka ZH 3x12 	2ks	2ks	2ks	2ks	2ks	2ks
28 úchytka LIONO 	1ks	2ks	1ks	2ks	1ks	2ks
29 skrutka M4x20 	2ks	4ks	2ks	4ks	2ks	4ks
30 zámok 	1ks	1ks	1ks	1ks	1ks	1ks
31 uholníková zarážka 	1ks	1ks	1ks	1ks	1ks	1ks
32 klapačka 	0ks	2ks	0ks	2ks	0ks	3ks
33 skrutka ZH 4x25 	0ks	4ks	0ks	4ks	0ks	0ks

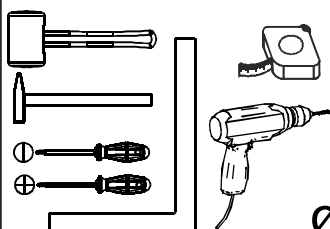
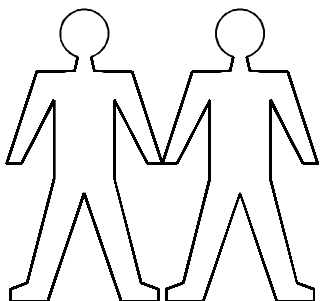

ø5

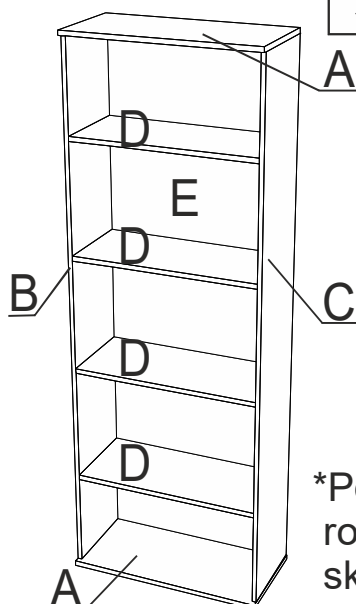

A	dno 1ks, strop 1ks
B	bok ľavý 1ks
C	bok pravý 1ks
D	polica
E	chrbát 1ks

*Postup montáže korpusu je rovnaký pre nasledujúce korpusy skriniek: 20, 20S, 30, 30S, 50, 50S

1 Montáž korpusu

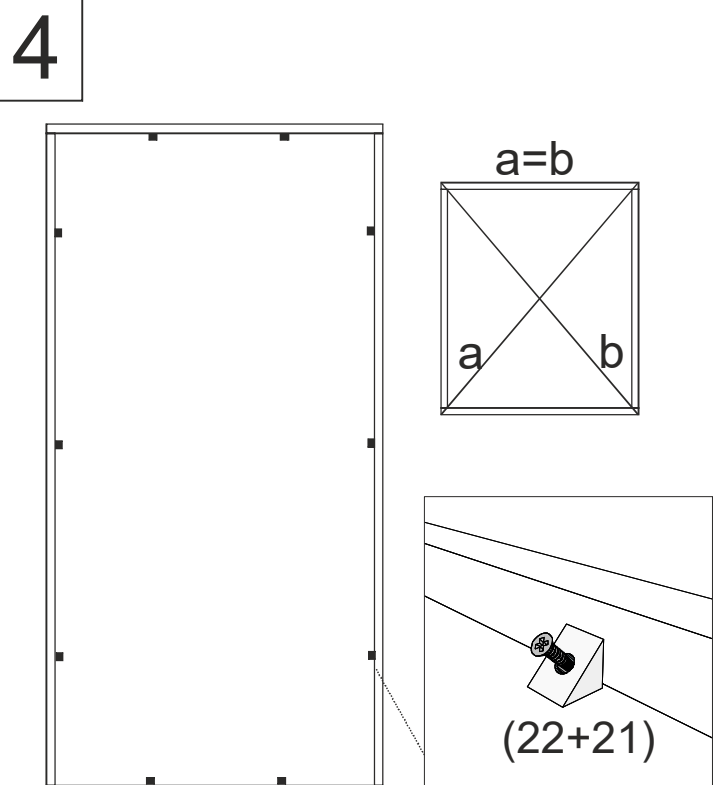
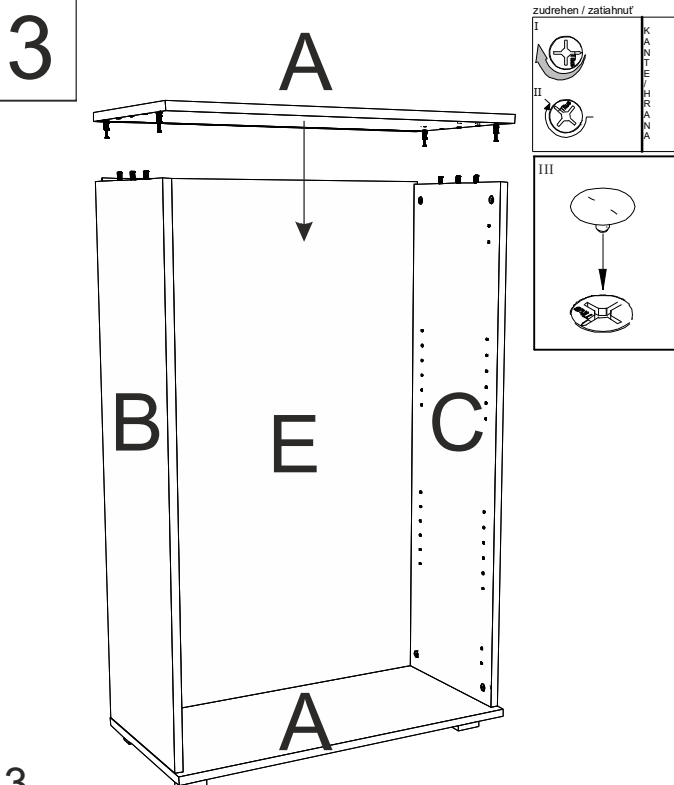
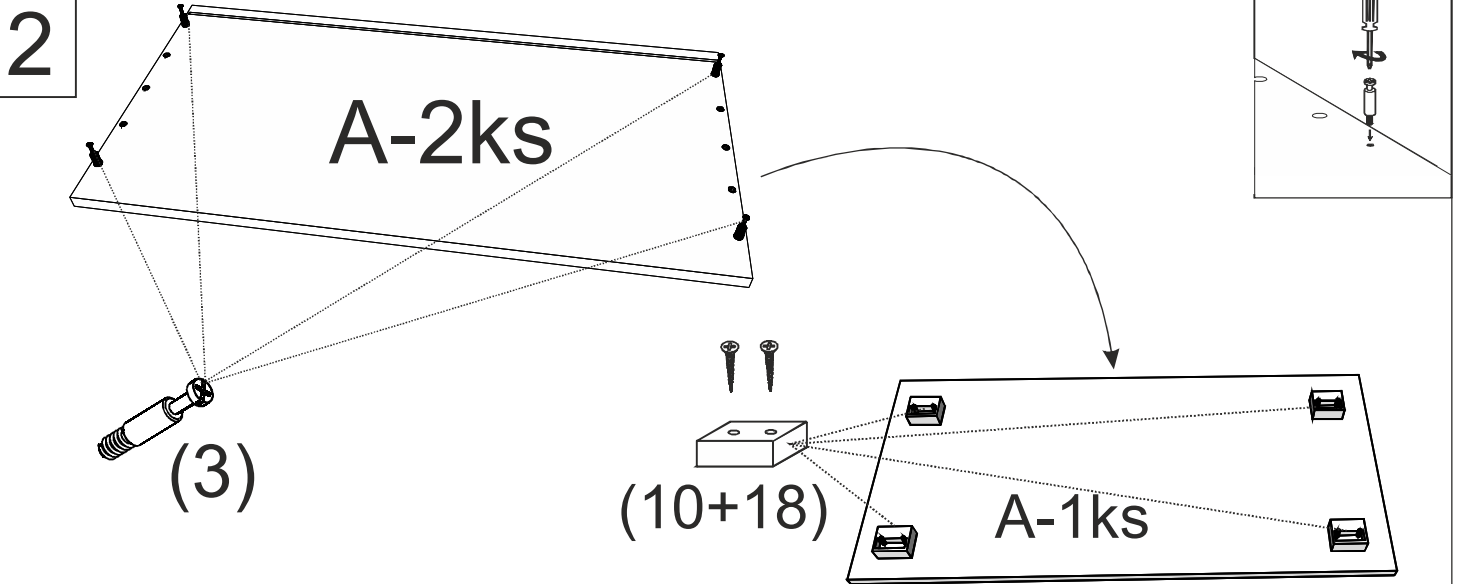
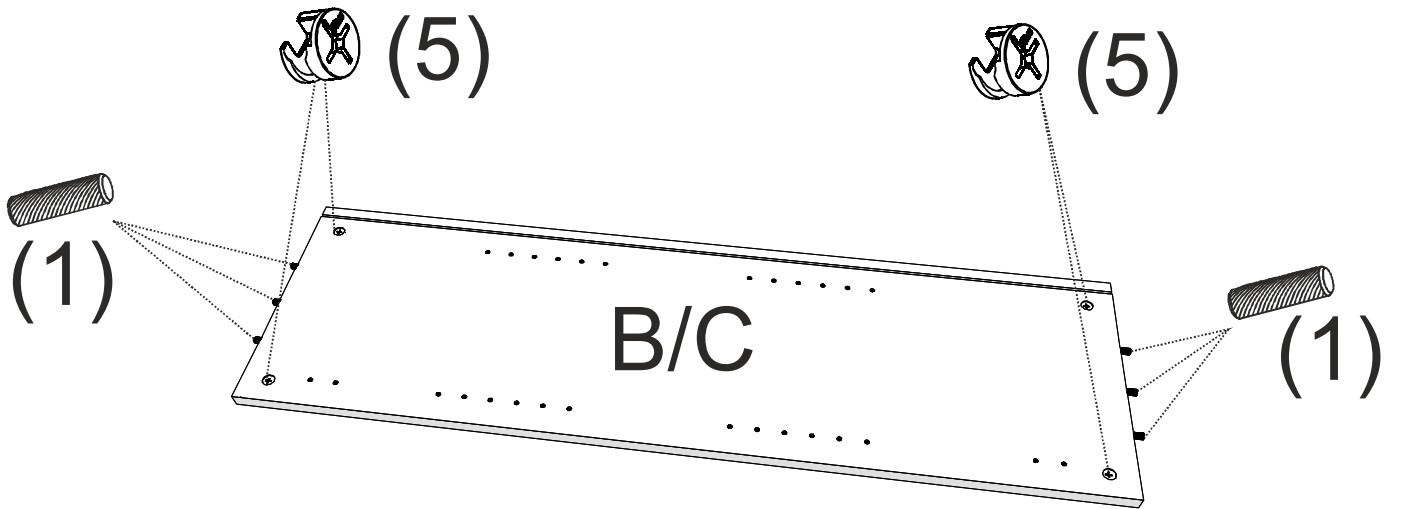

5

(20) 

(21) 

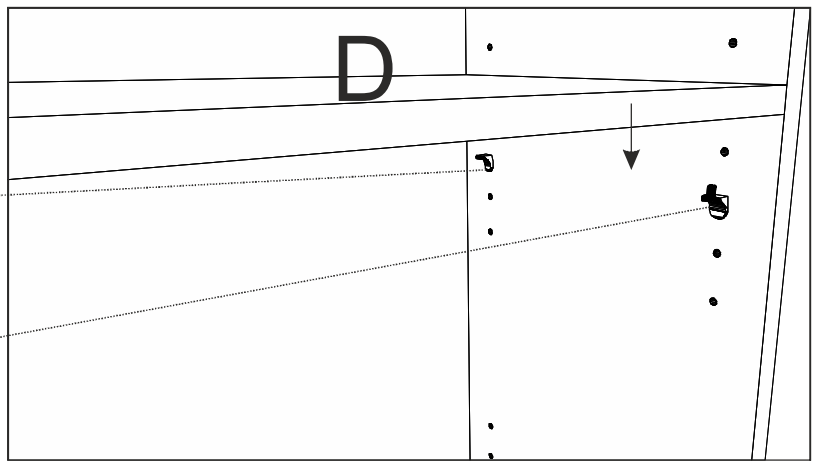

* pri nasledujúcej kombinácii korpusu a dvierok umiestnite policu v stanovenej výške pre správnu funkciu uzamykania!!!

S50+D5 (2ks)

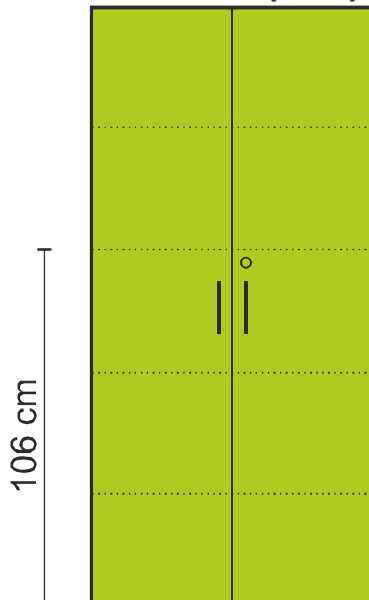

S50+D3(2ks)

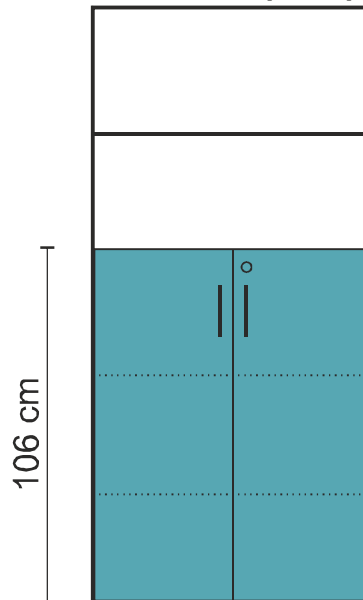

S50+D2(2ks)

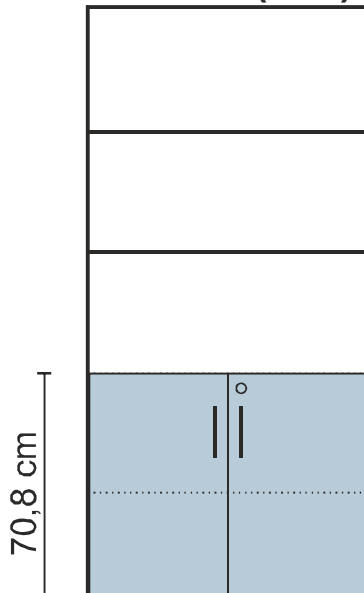

S30+D2(2ks)

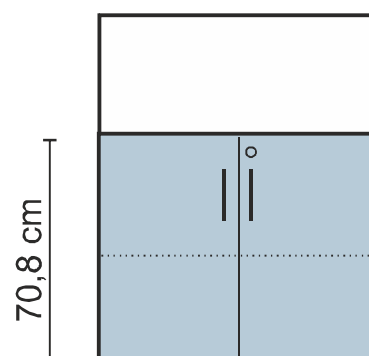

6

Montáž dverí

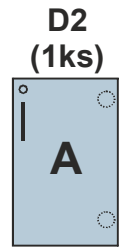
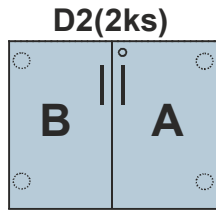
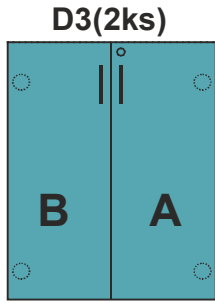
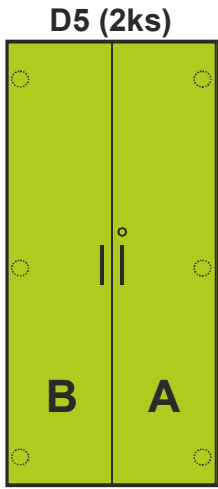

montáž zámku pre S20, S30, S50
UZAMYKANIE NAHOR (do police/stropu)

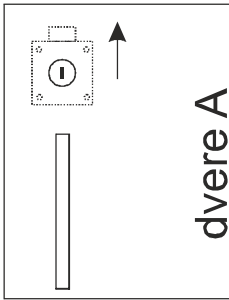

montáž zámku pre 20, 30, 50
UZAMYKANIE NA STRANU (do boku)

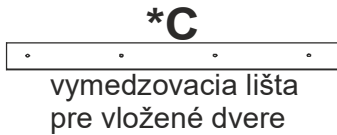
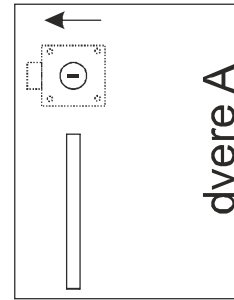

*dielec sa dodáva iba k niektorým typom dverí

7

Rozmiestnenie dielu č. 8 pre jednotlivé typy dverí.
Rozmery sú platné pre všetky typy korpusov.

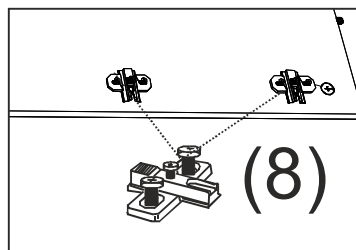
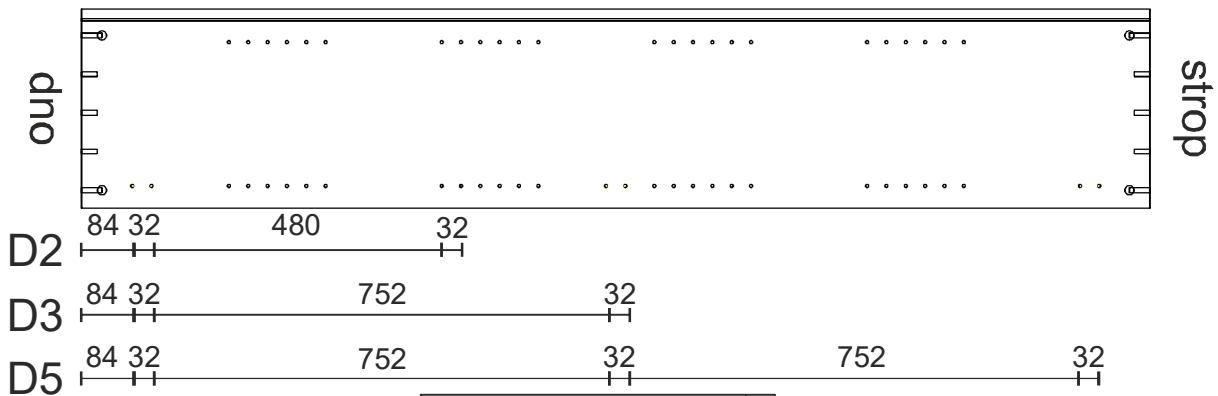

8

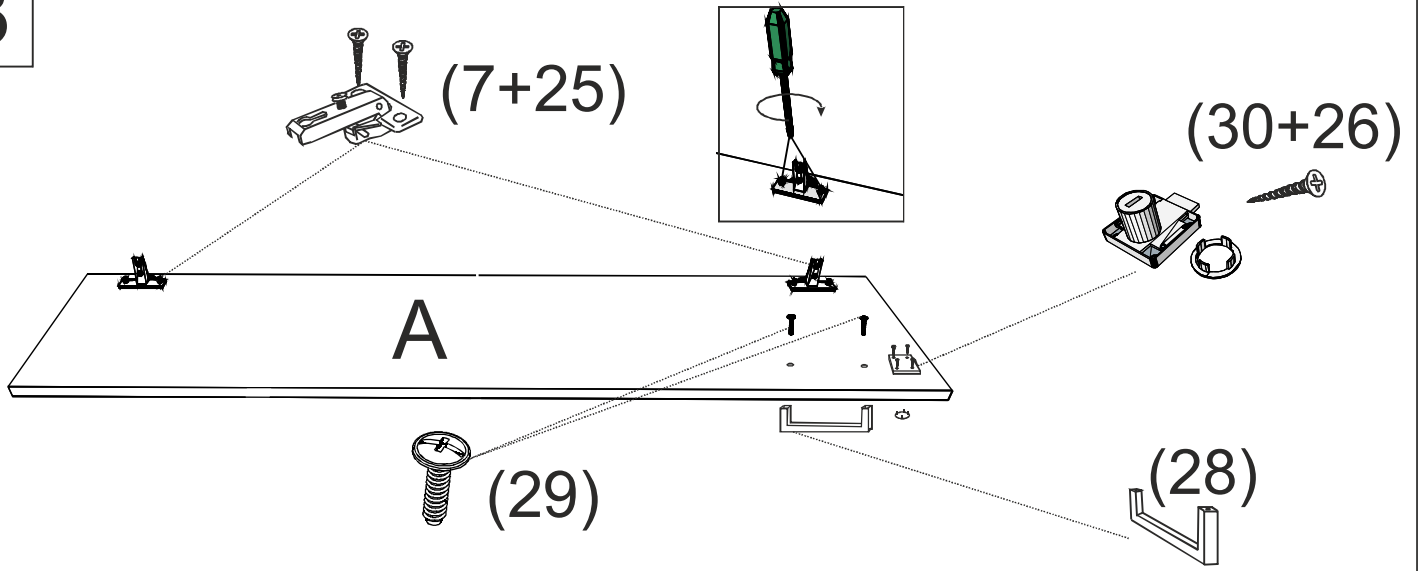

9

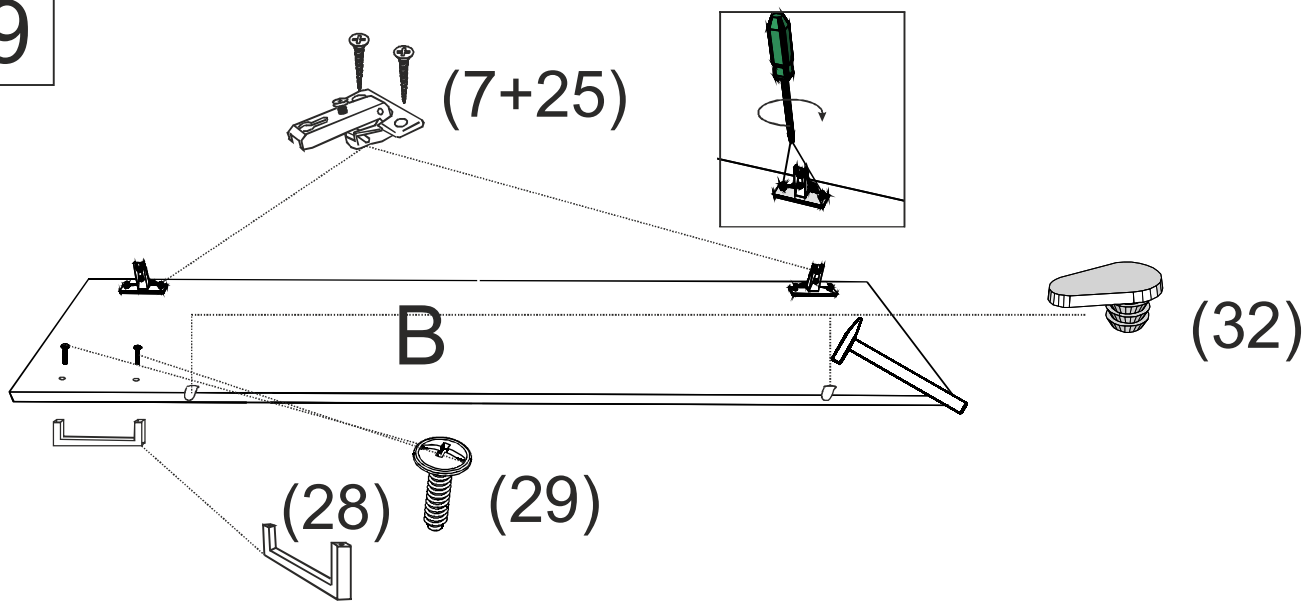

10

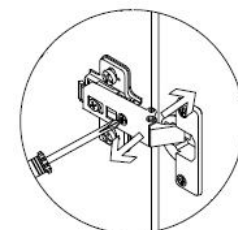
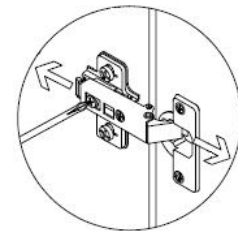
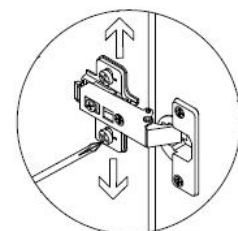
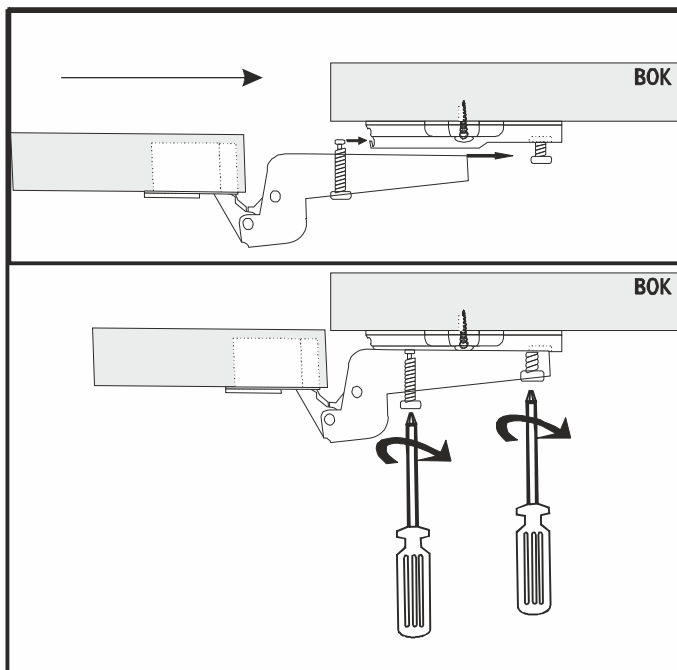

11



Tento krok montáže vykonajte iba v nasledujúcich kombináciách:
S30+D3, S20+D2

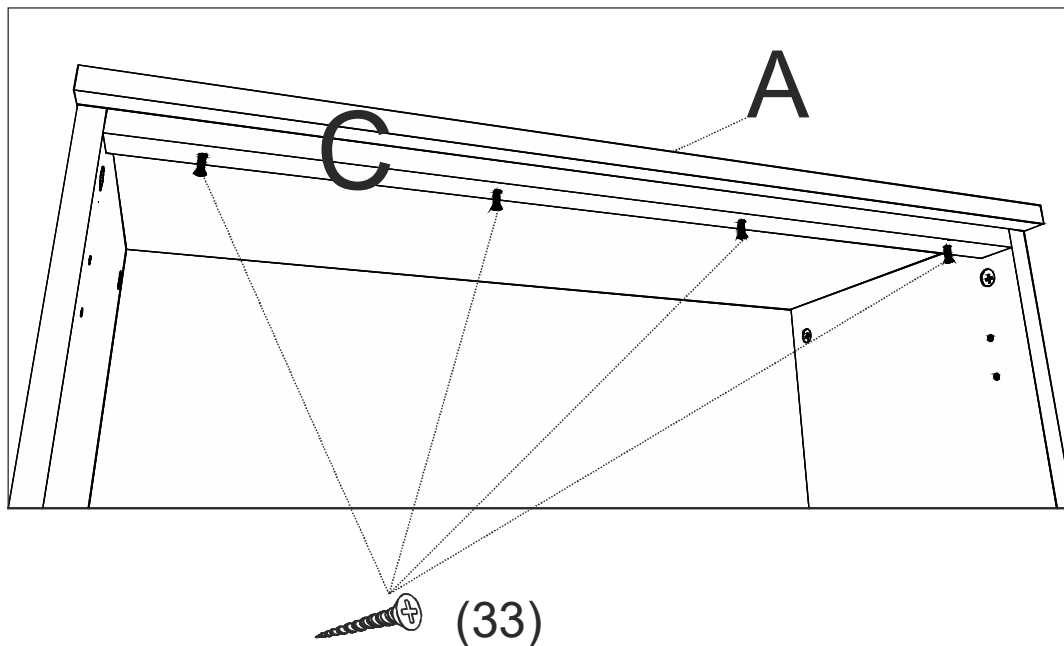

12

Montáž uholníkovej zarážky
(27+31) vykonajte podľa typu dverí,
výška uloženia police na str. 4.

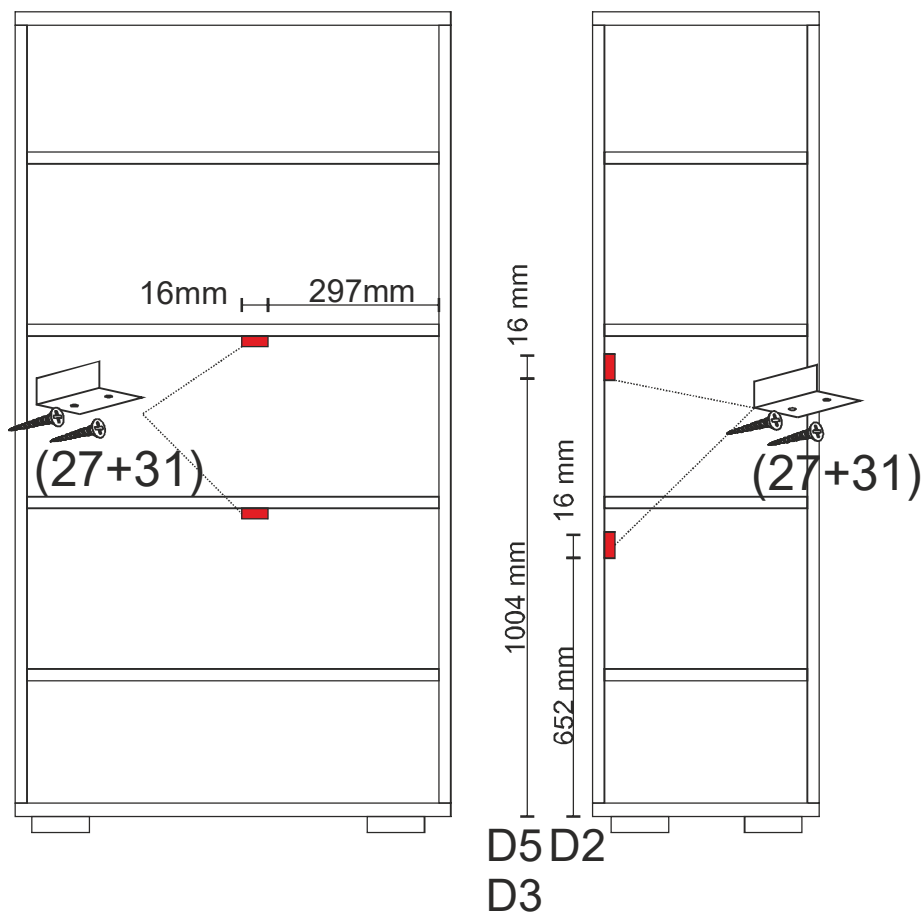

13

Zaistenie police,
v prípade kombinácii
korpusu a dverí, zaistite
policu na mieste
kde sa nachádza
uholníková zarážka č.31

