

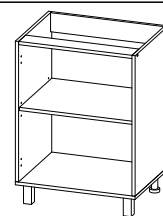

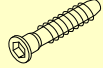









DREVONA®
N Á B Y T O K

REA ALFA
KD-60-72
600-450-816



	 $\varnothing 8 \times 30$						 $\varnothing 4 \times 16$	 $\varnothing 4 \times 16$	 $\varnothing 4 \times 30$										
A	10x	B	4x	C	2x	D	2x	E	2x	F	2x	H	4x	J	24x	K	2x	L	2x

 $\varnothing 1,6 \times 20$	
M	20x

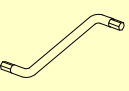
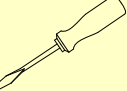
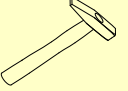
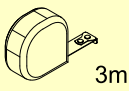
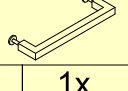
				 3m	 1x
---	---	---	---	--	--

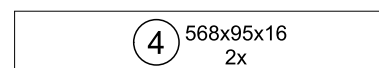
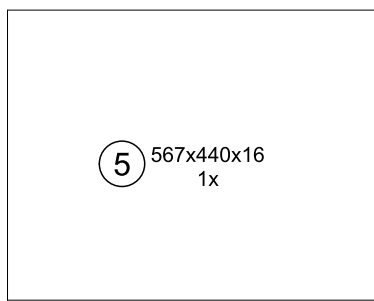
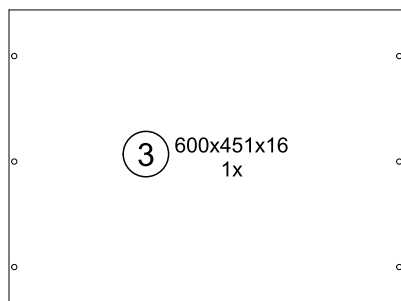
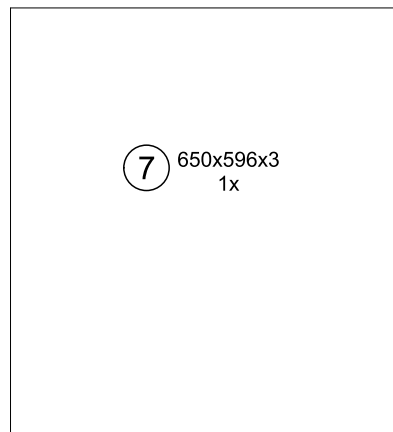
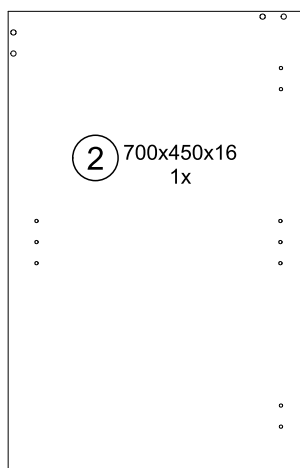
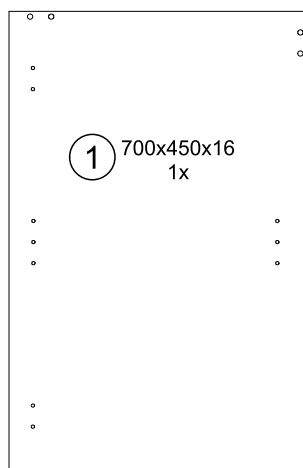
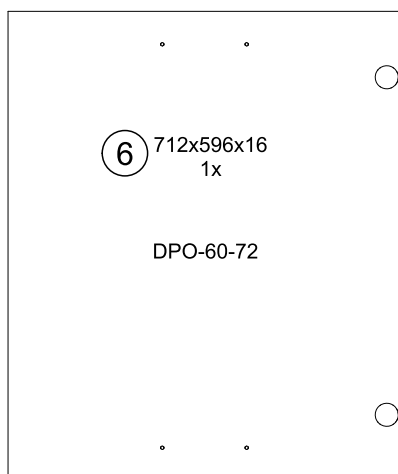

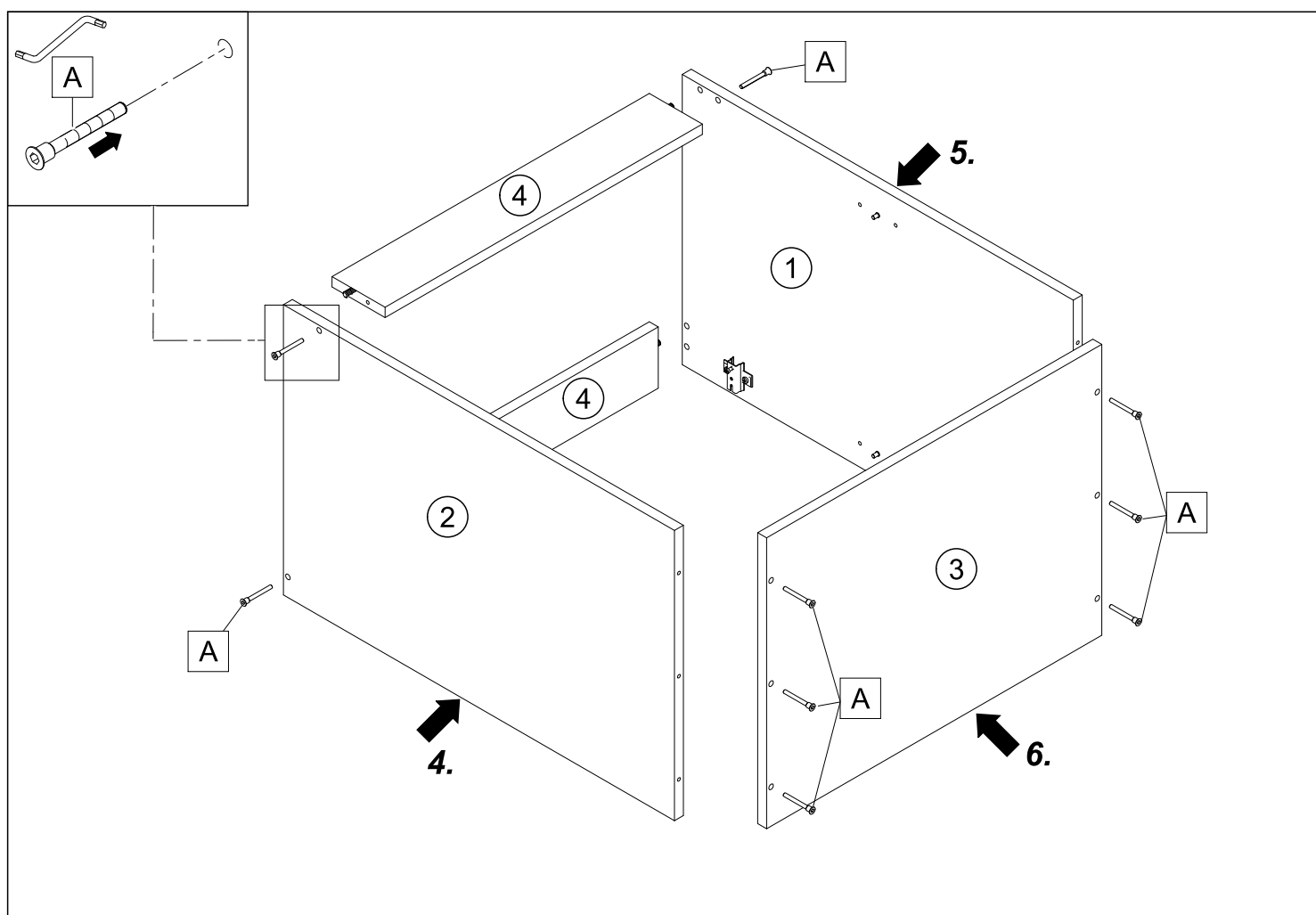
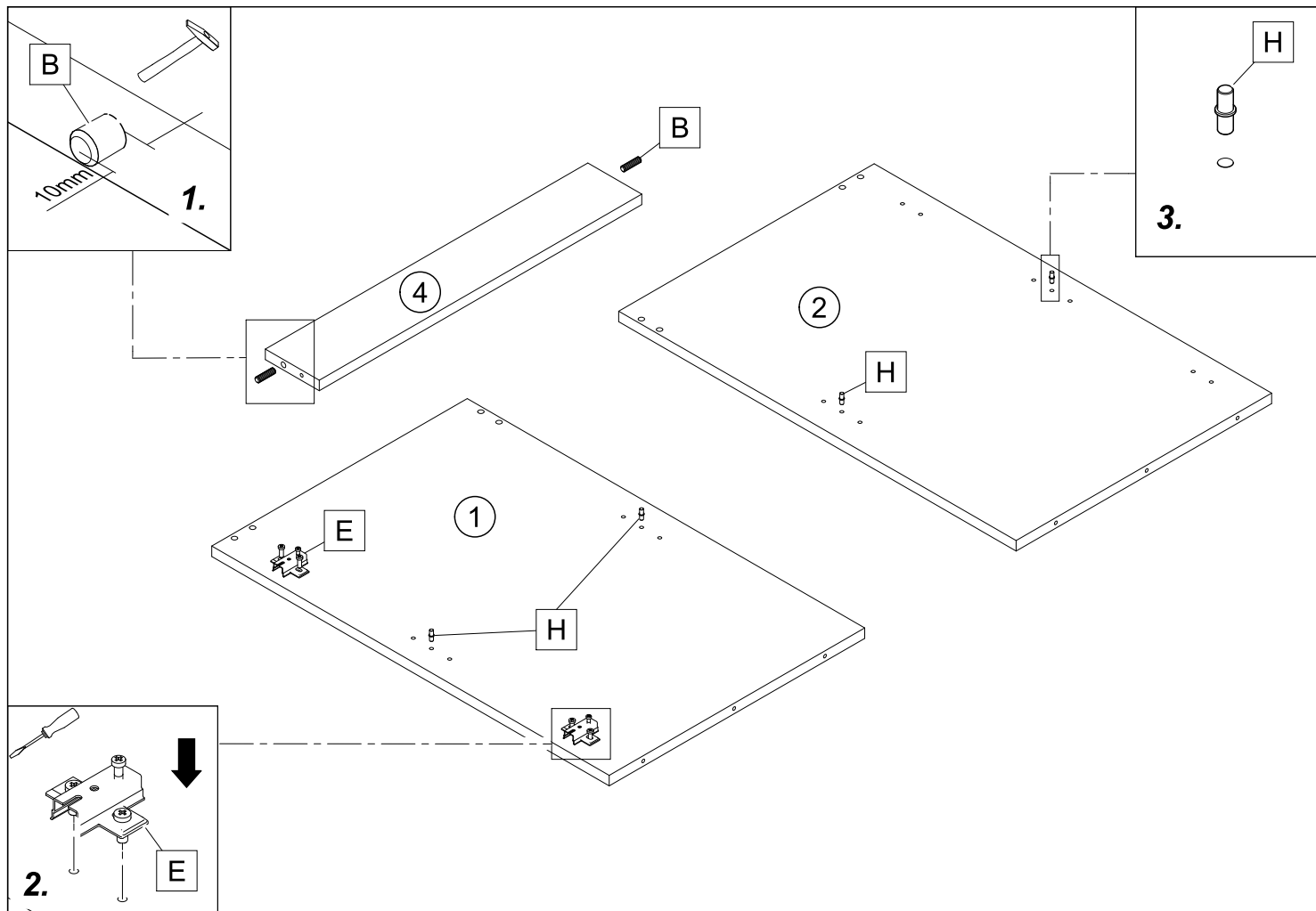

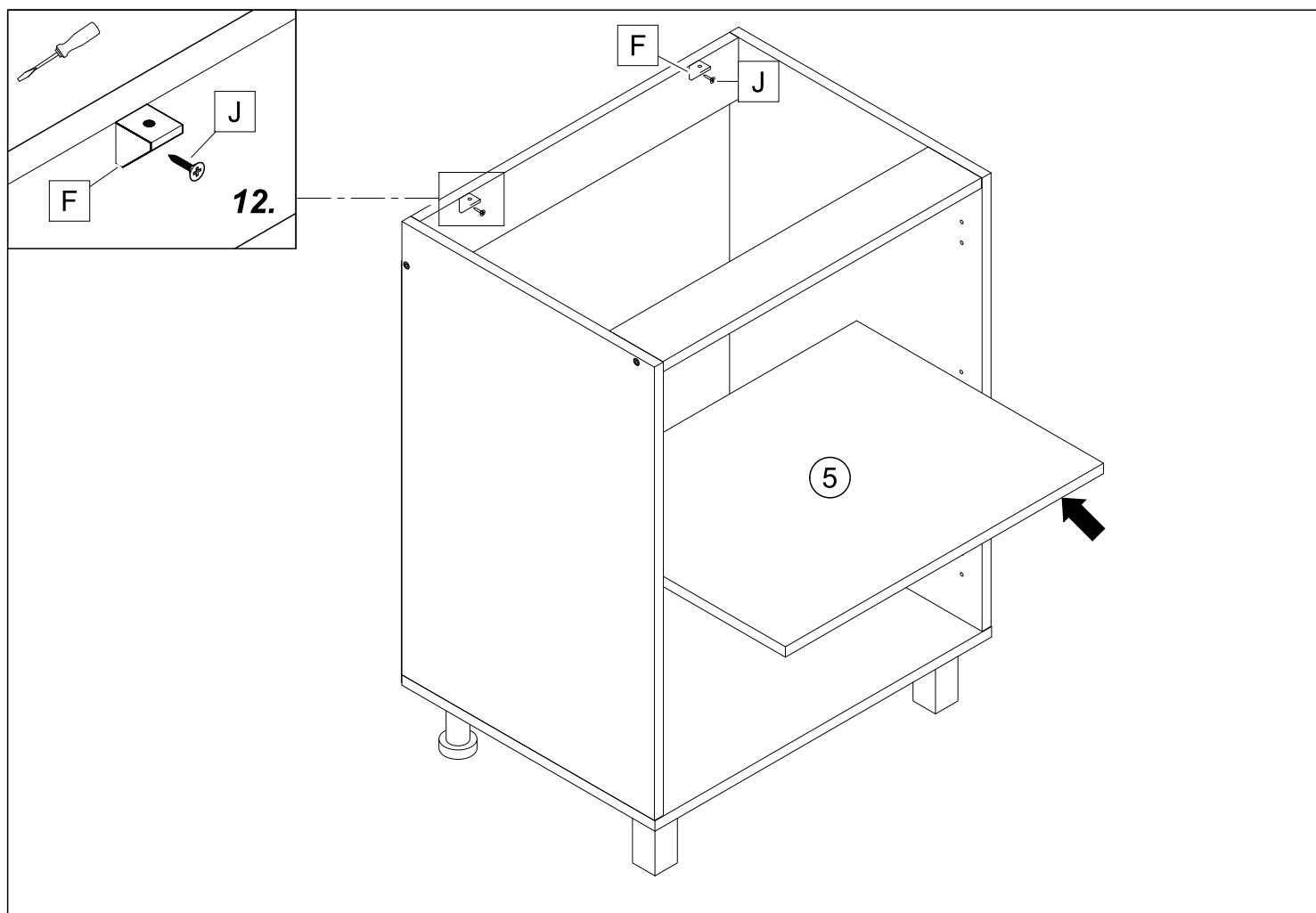
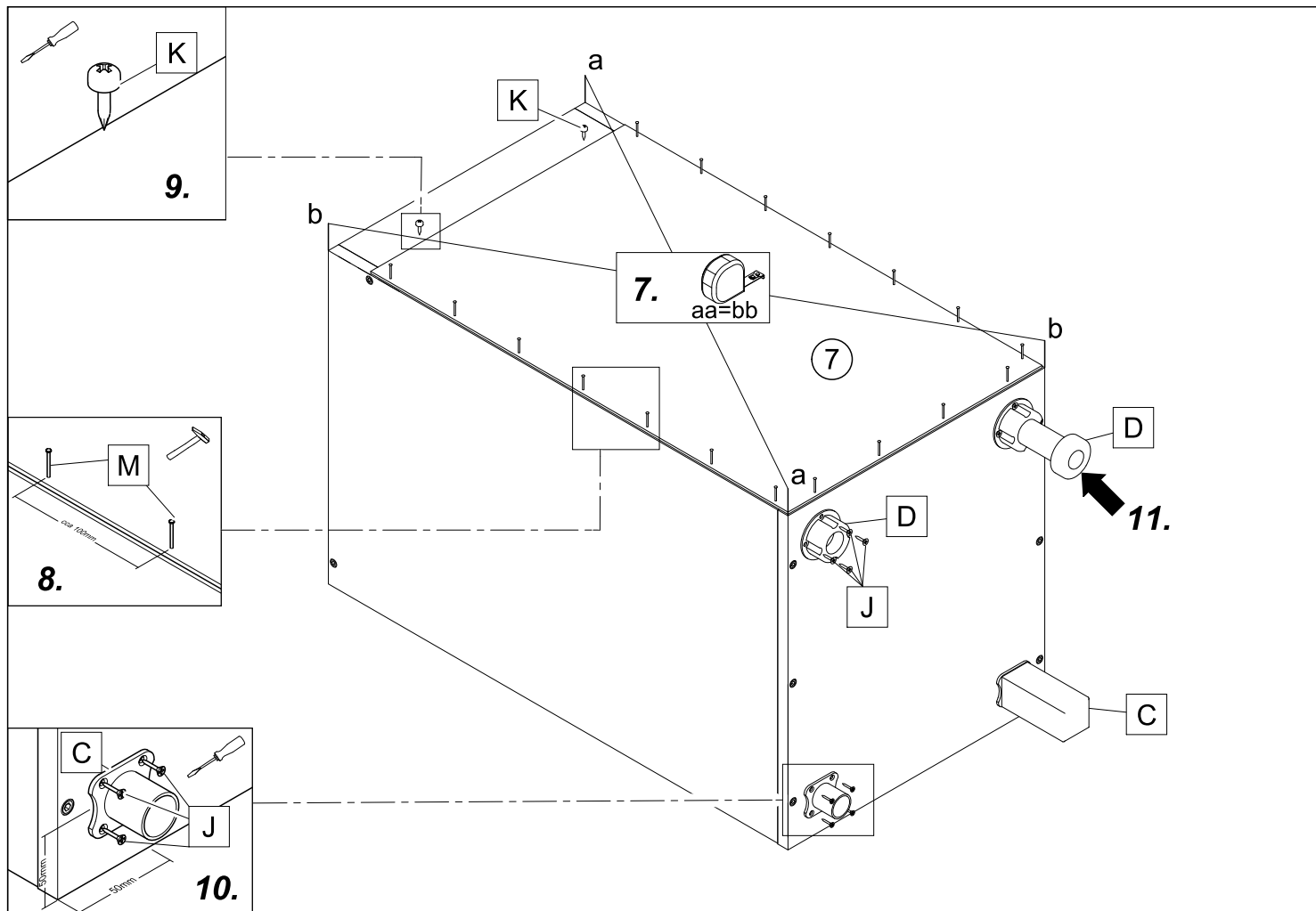

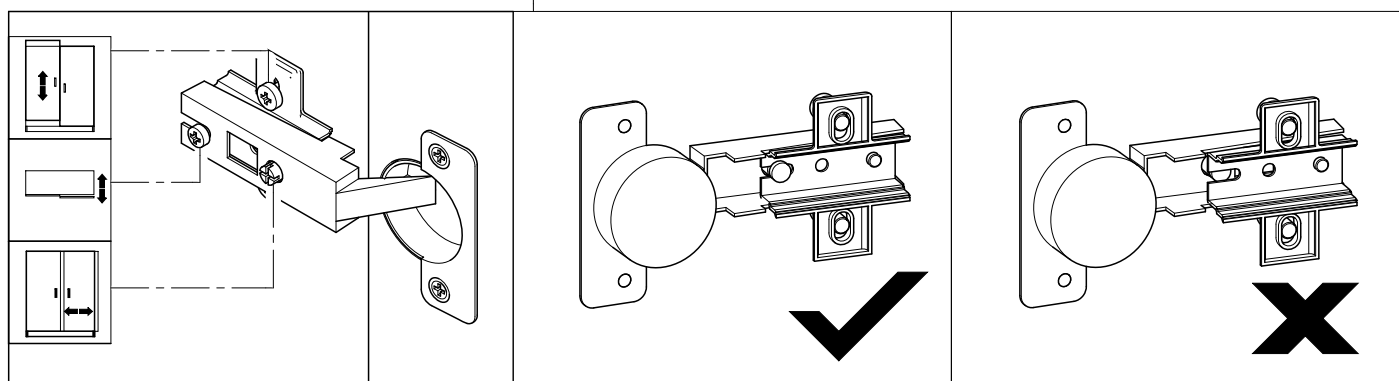
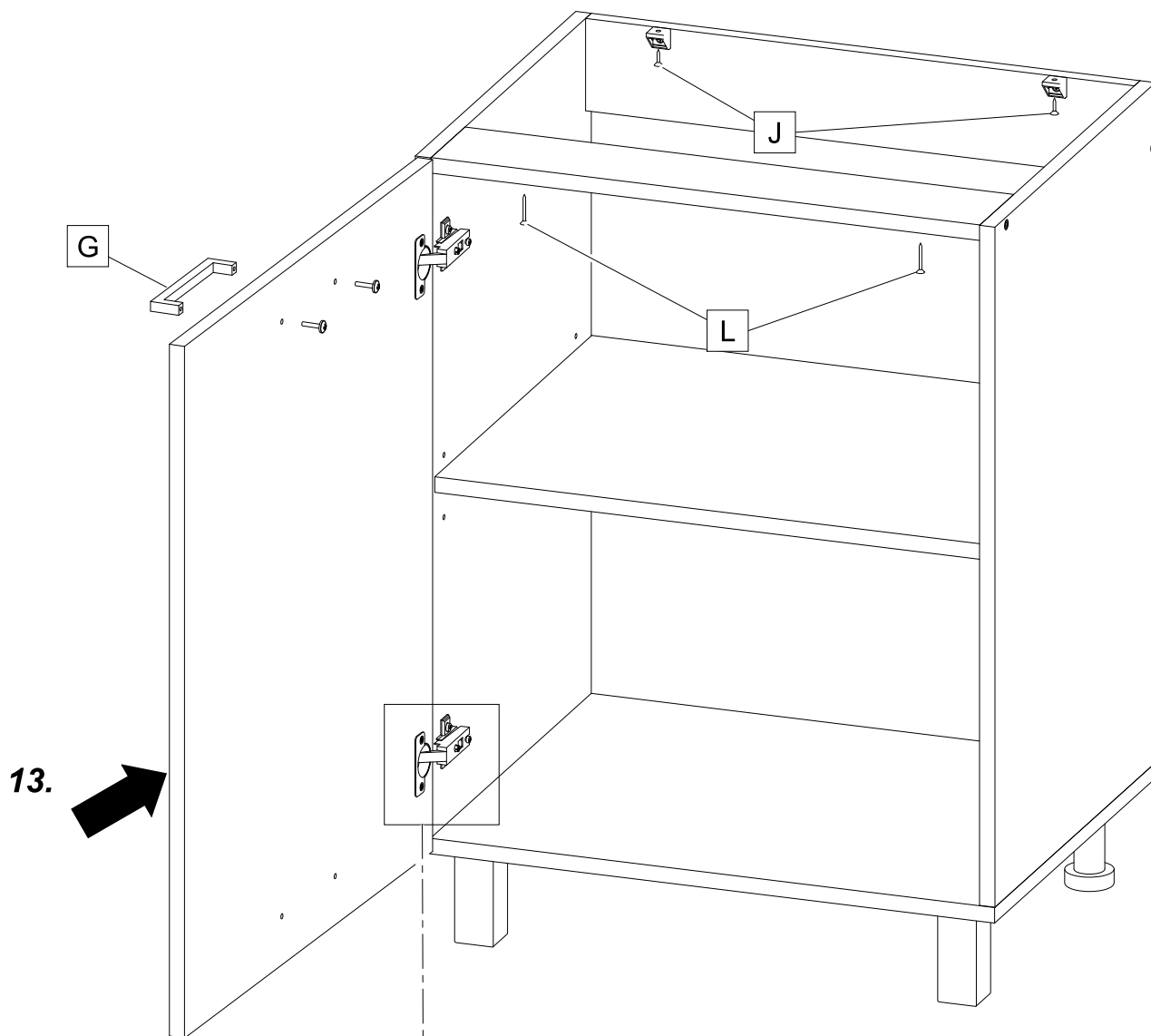





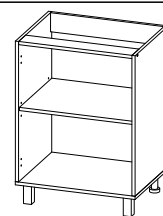

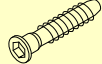







DREVONA®
N Á B Y T O K

REA ALFA
KD-60-72
600-450-816

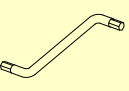
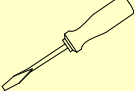
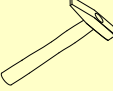

									
A	B	C	D	E	F	H	J	K	L
10x	4x	2x	2x	4x	2x	4x	28x	4x	3x

M
20x

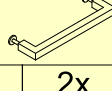
					
				3m	2x

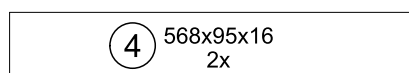
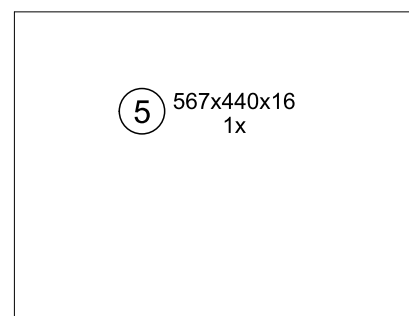
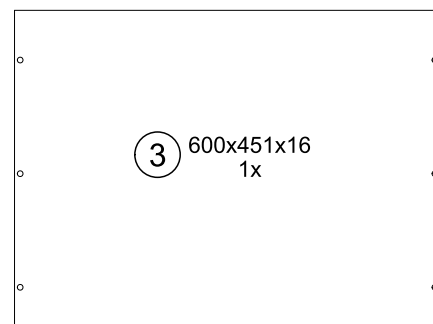
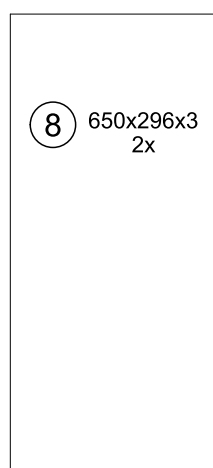
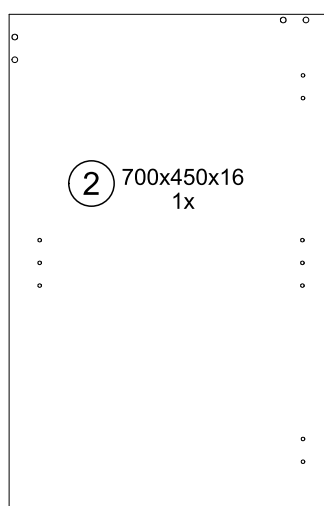
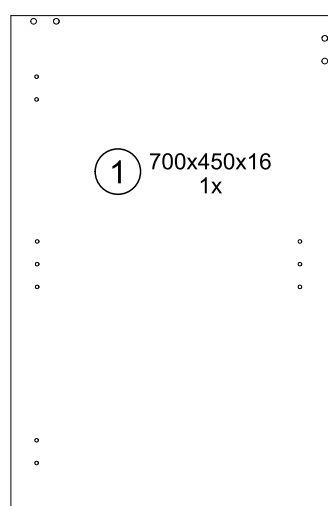
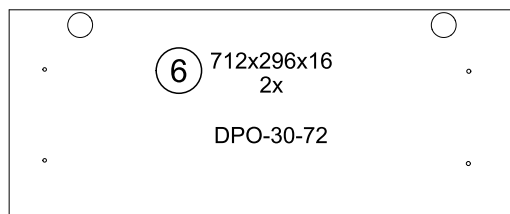

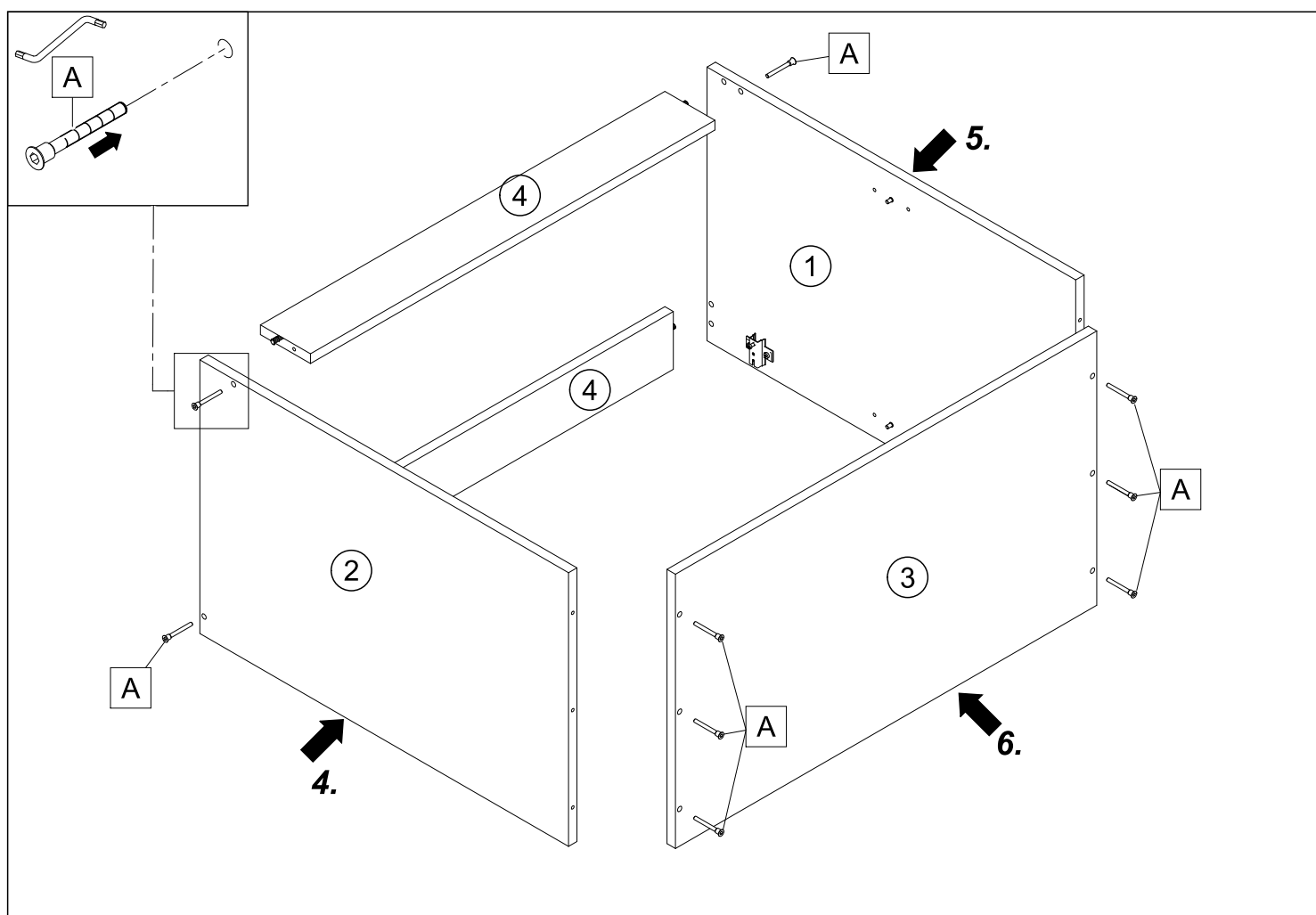
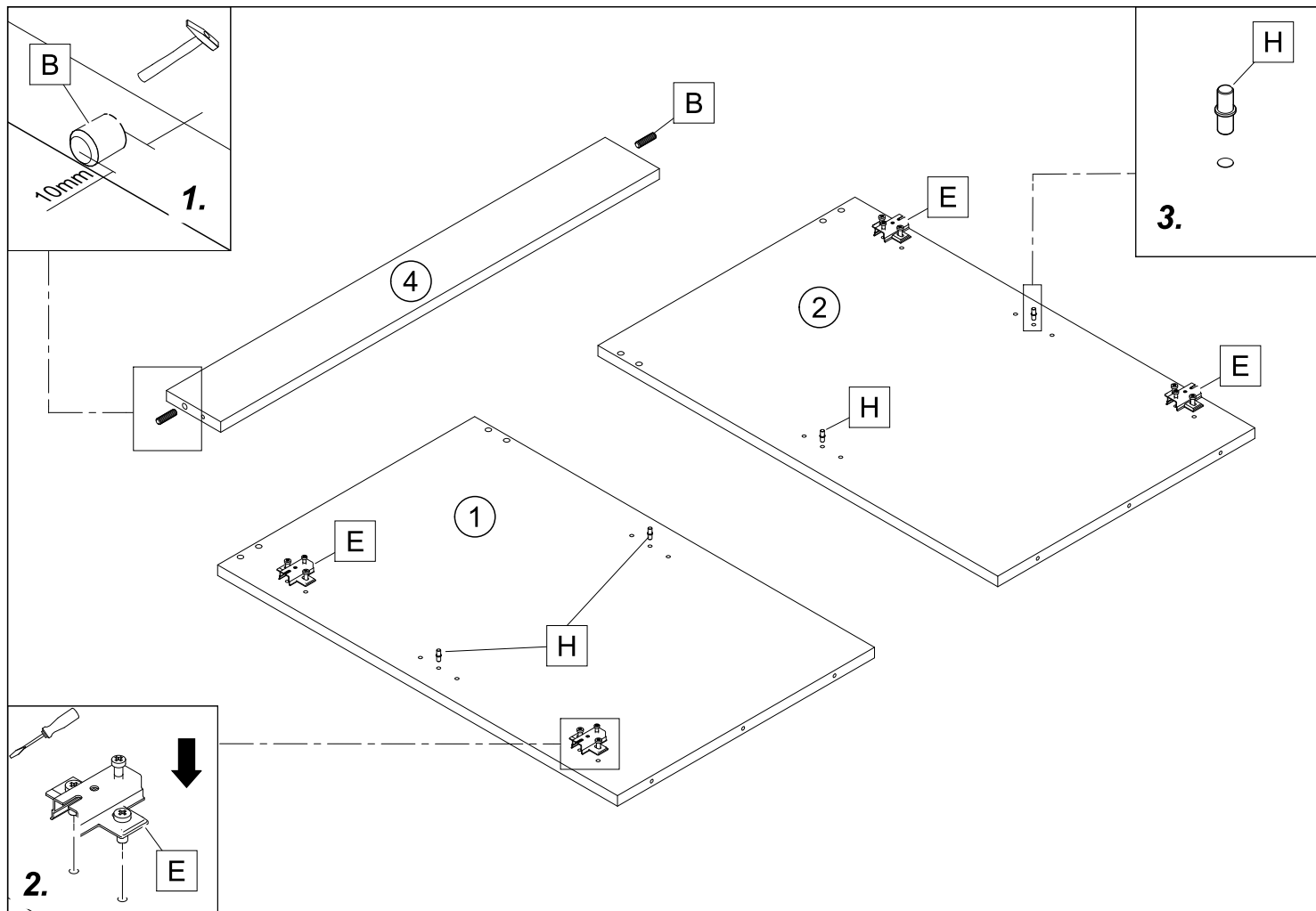

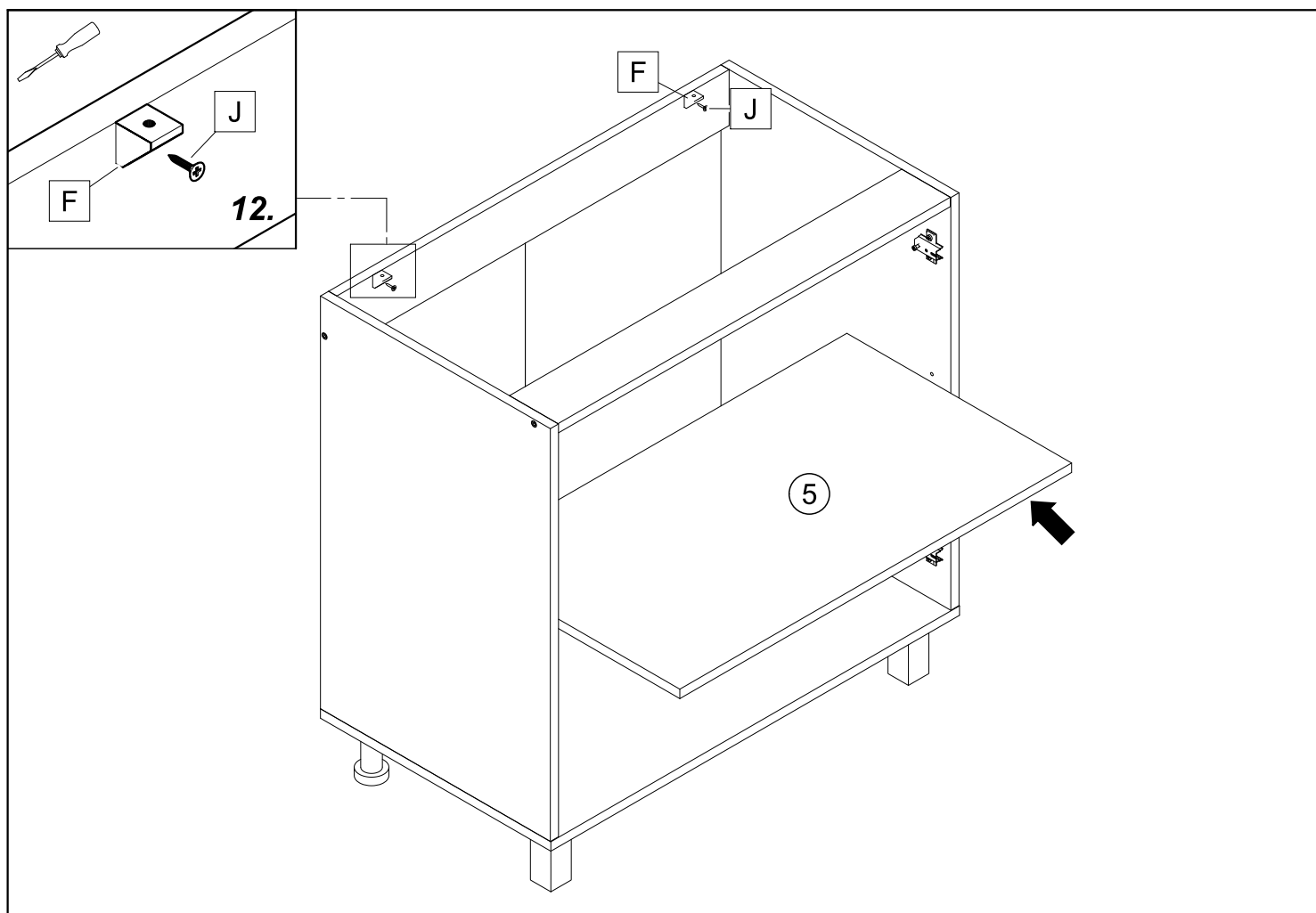
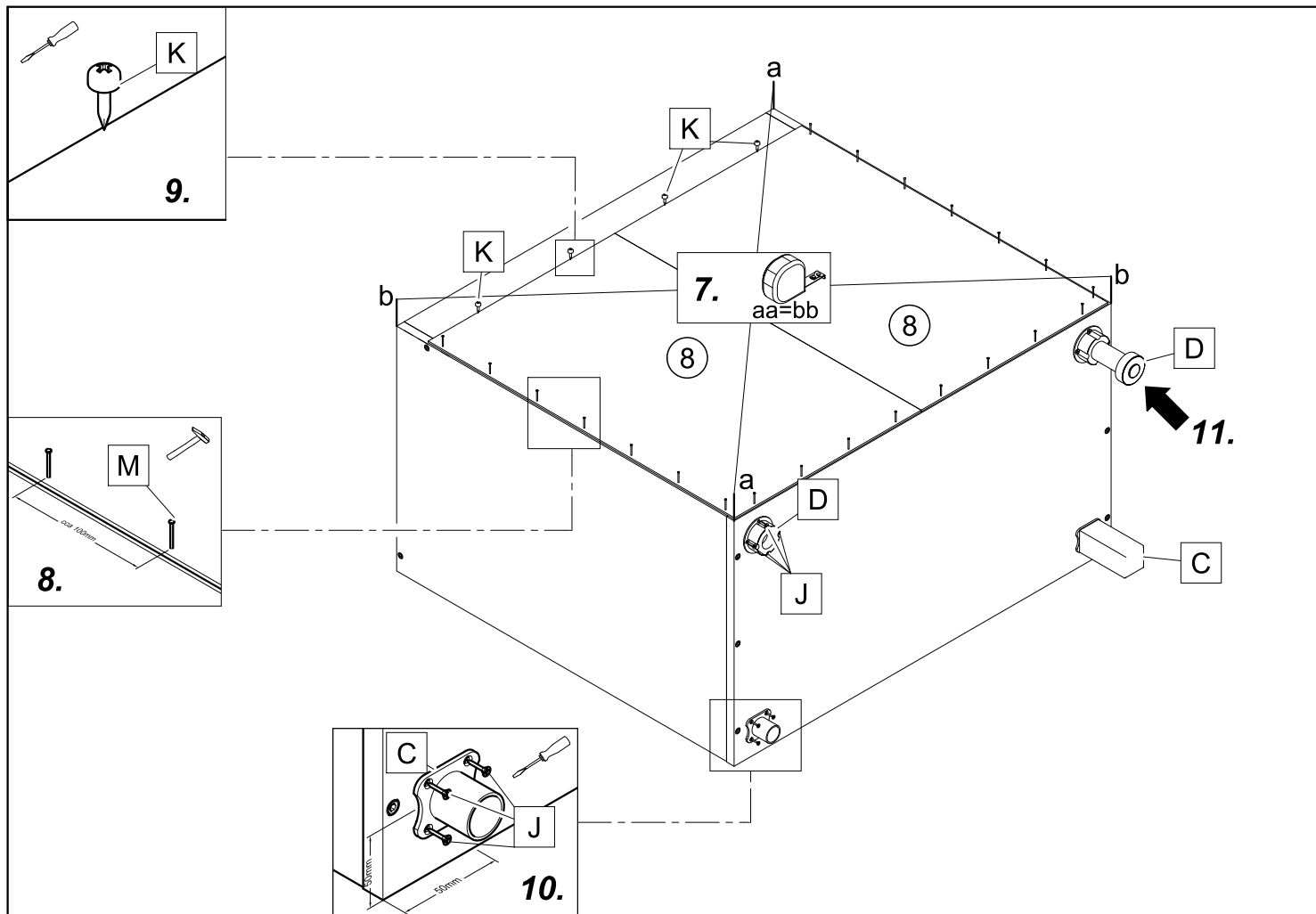

13.

