

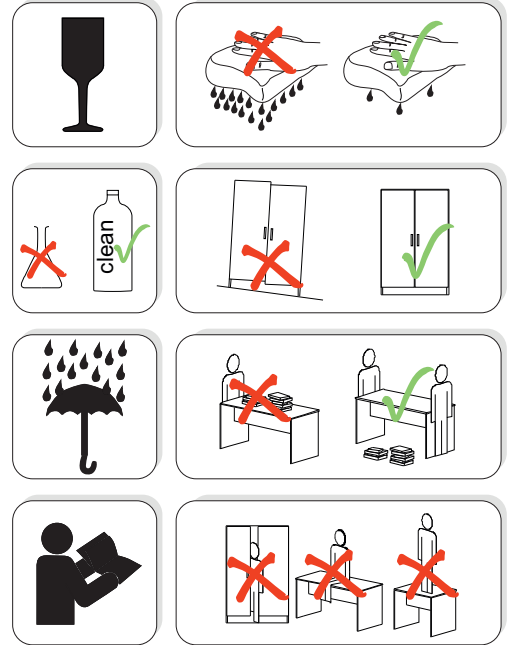

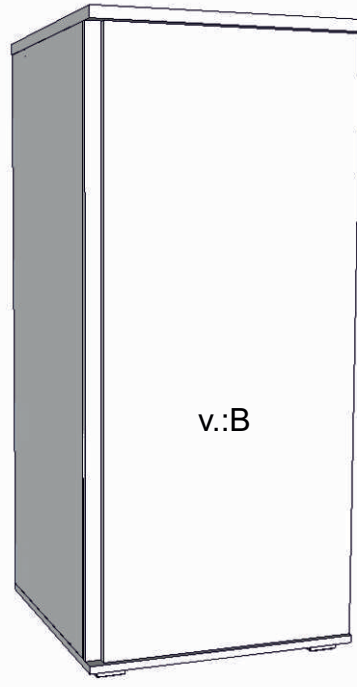

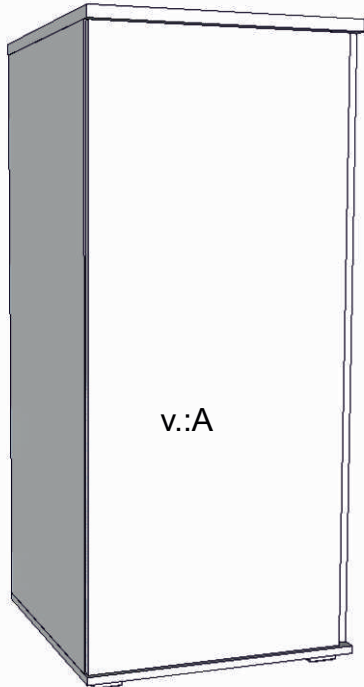









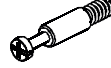

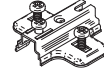

REA AMY

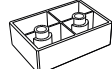
27/225

	600
	2250
	600



1/1

1 	3 	5 	6 	7 	8 	9 							
kolík 8x35	18ks	ťahlo	27ks	excenter	27ks	krytka	27ks	záves naložený	4ks	podložka závesu	4ks	skrutka zh 4x16	13ks
10 	11 	18 	24 	28 	31 	32 							
klzák Herman	4ks	klinec 1,2x25	60ks	skrutka zh 5x25	8ks	doraz	2ks	bezpečnostný uholník	1ks	vešiaková tyč 555 mm	1ks	úchyt veš. tyče	2ks
33 													
štetina 2183mm	1ks												

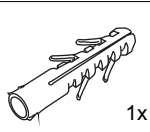
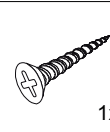
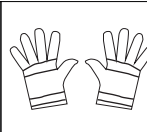
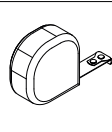
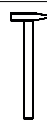
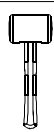
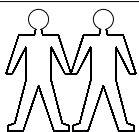

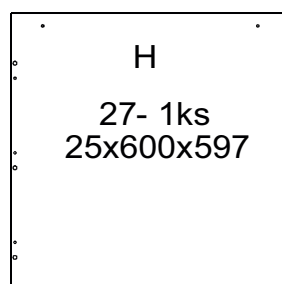
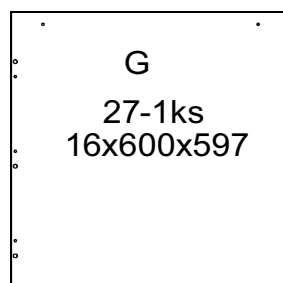
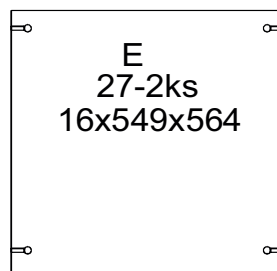
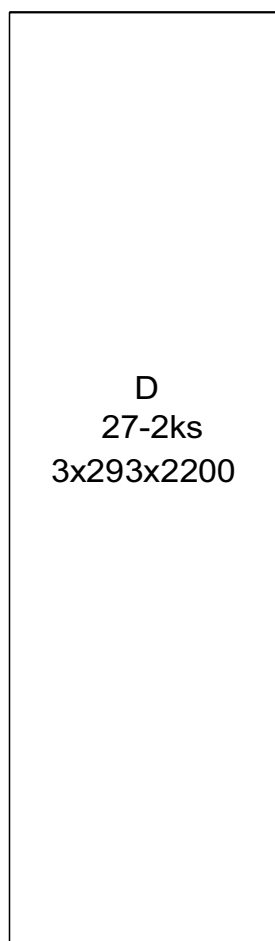
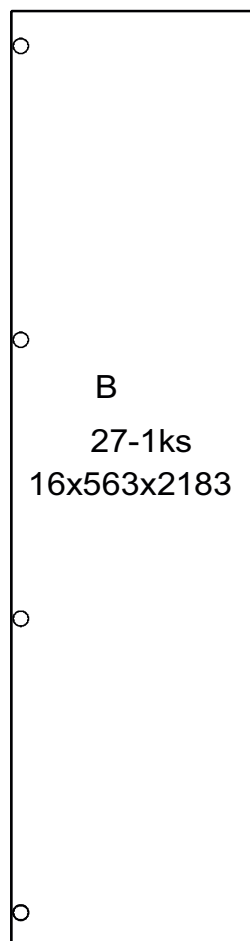
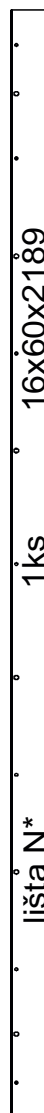
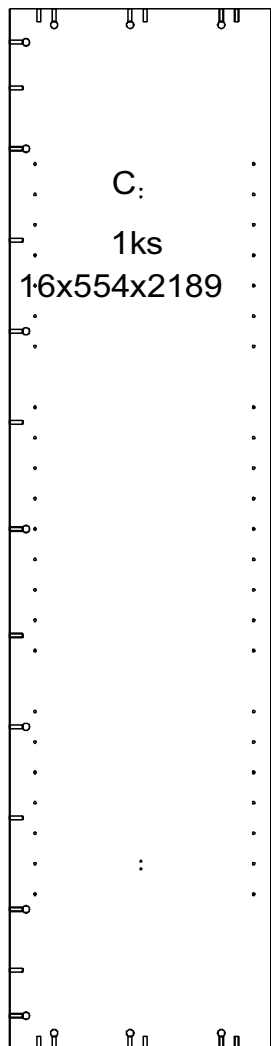
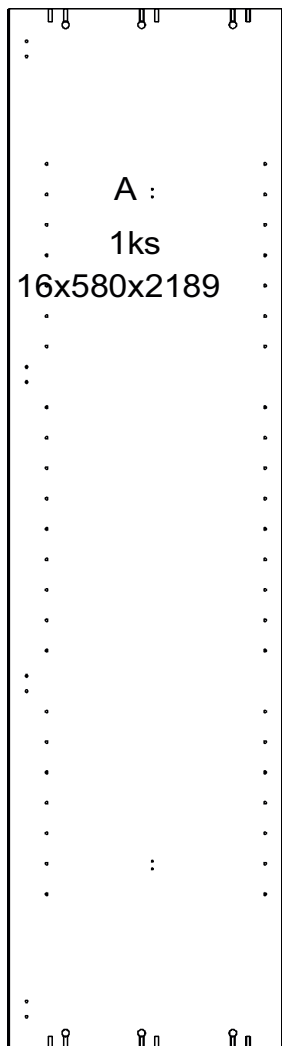

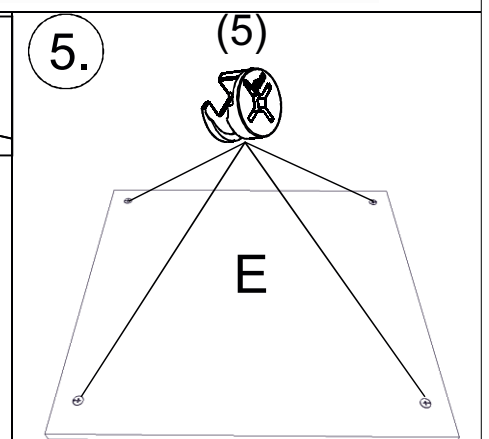
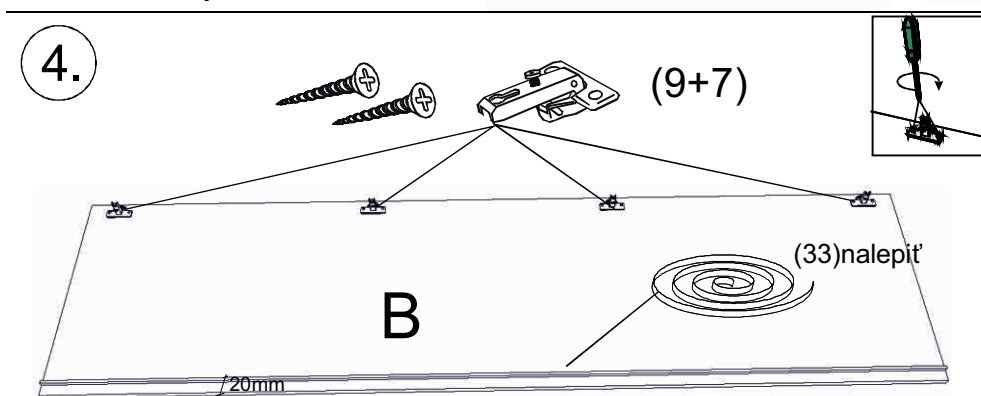
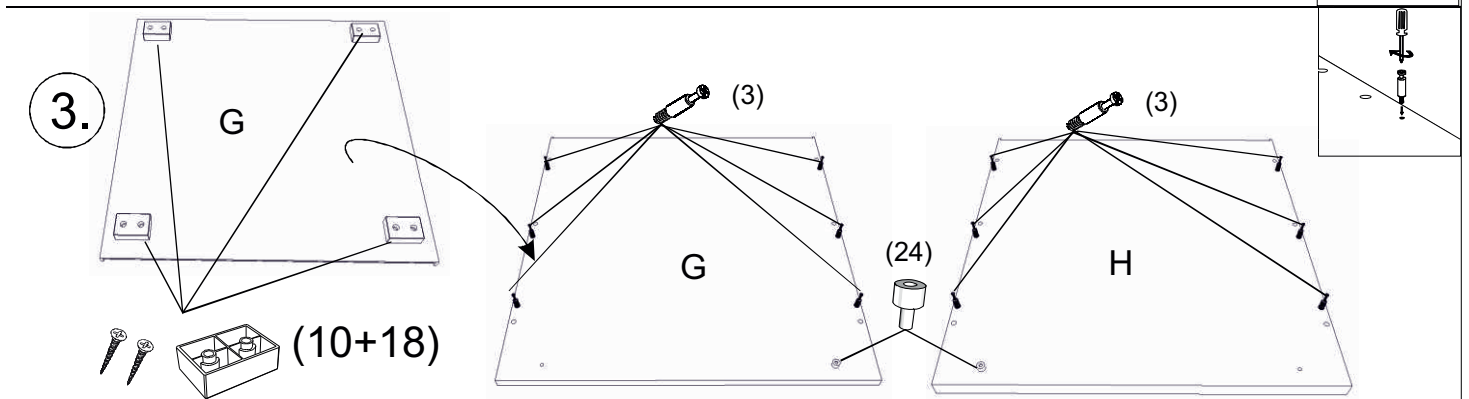
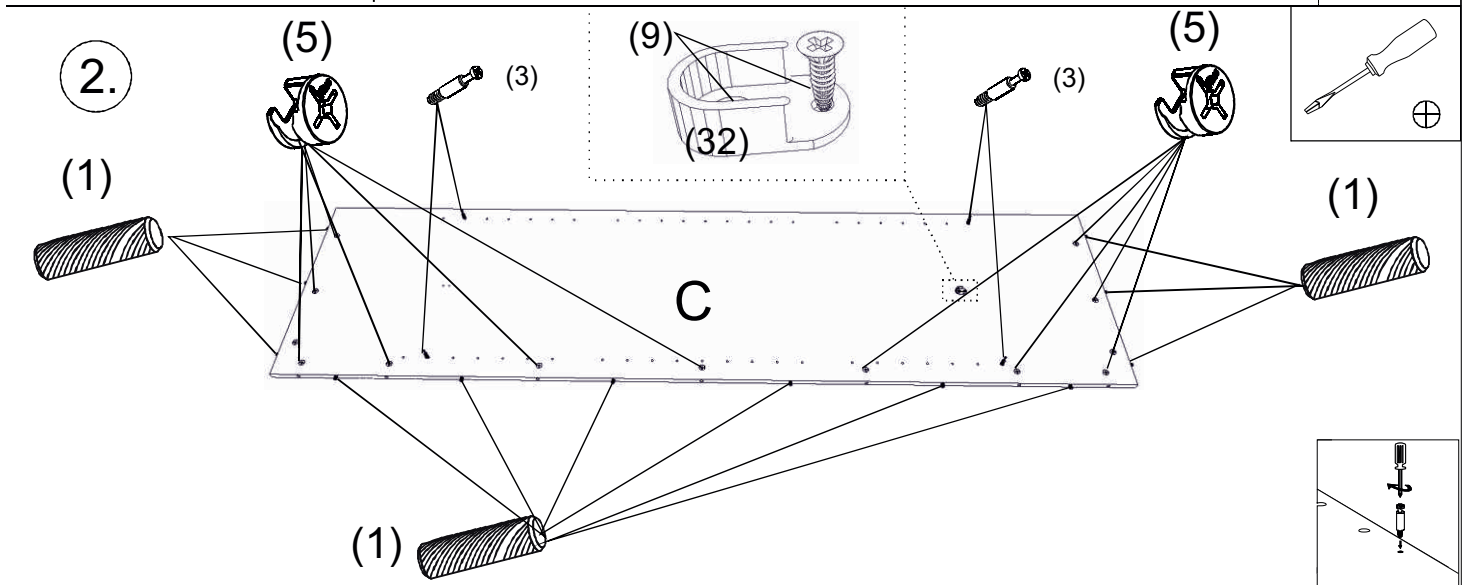
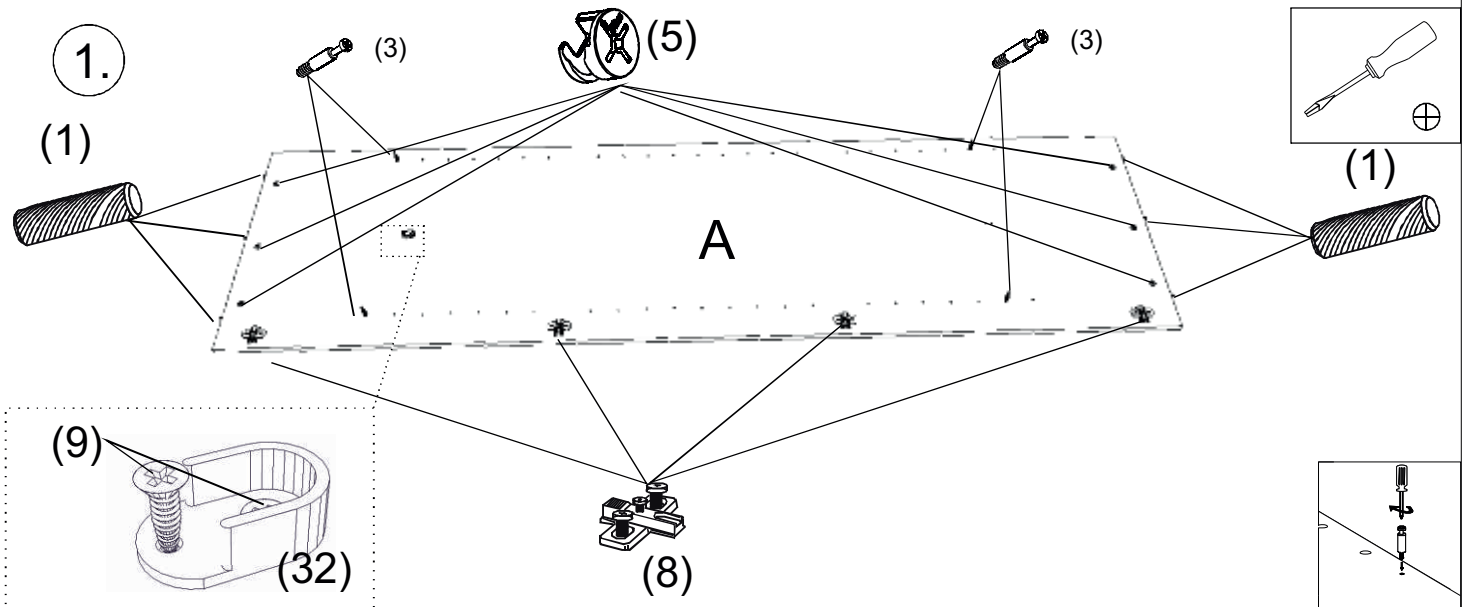

6.

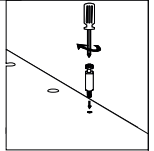
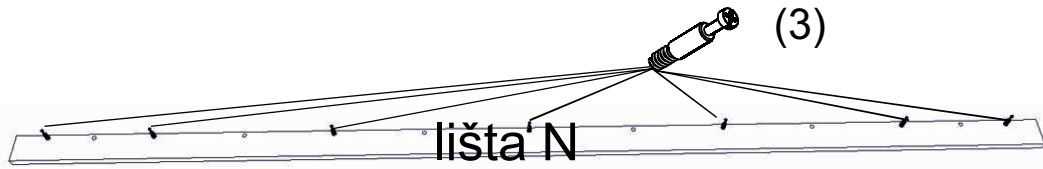

7.

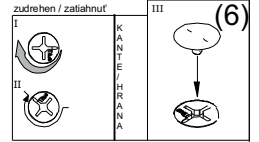
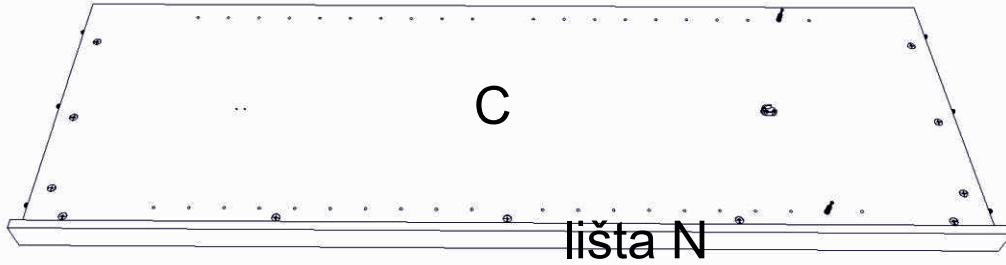

8.

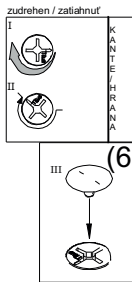
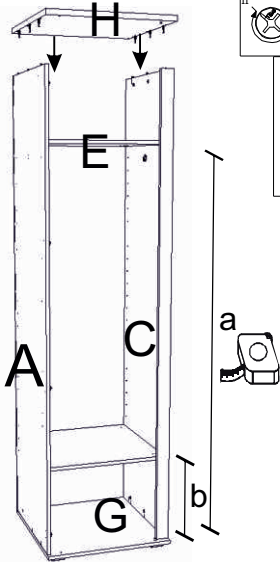

9.

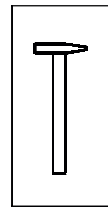
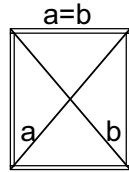
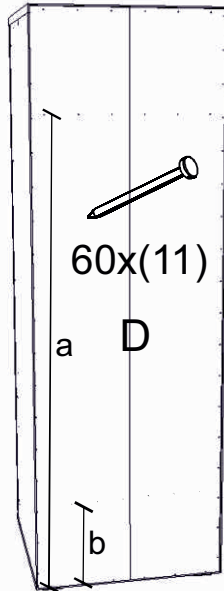

10.

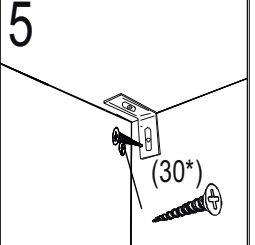
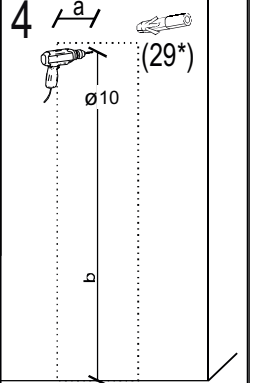
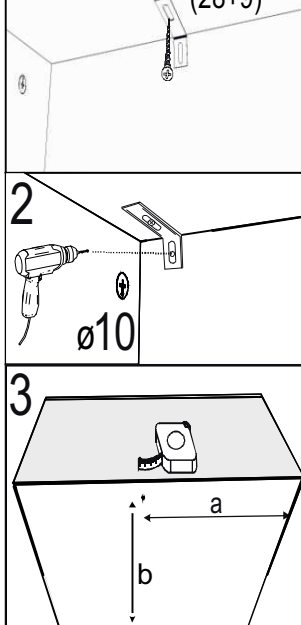

11.

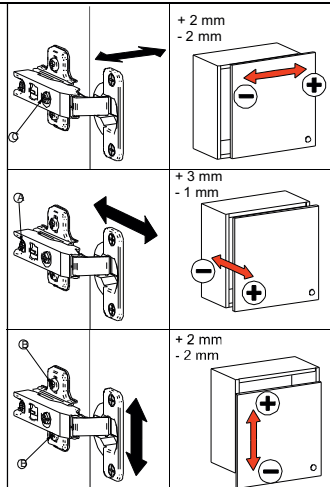
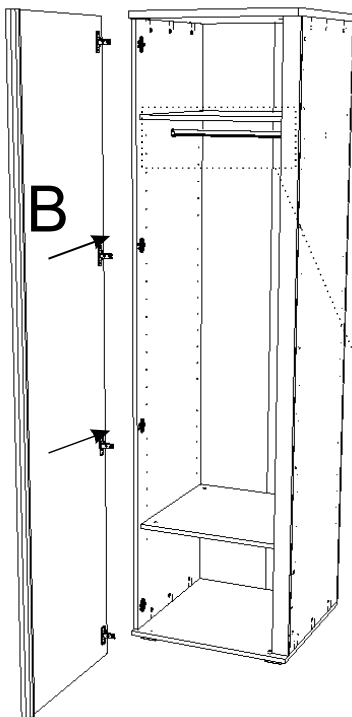

12.

