

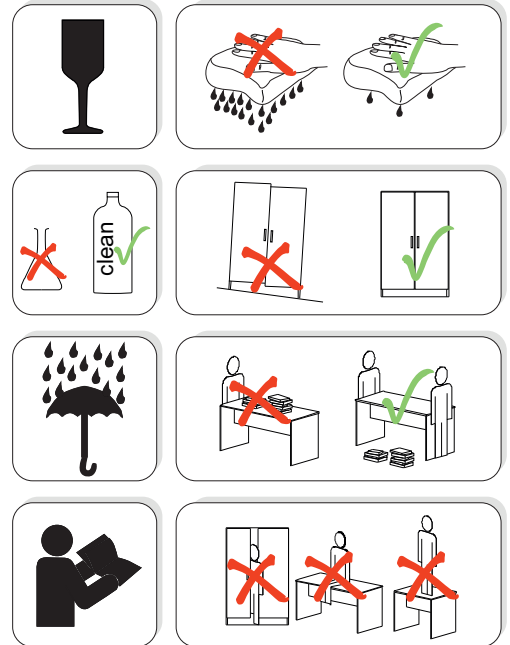

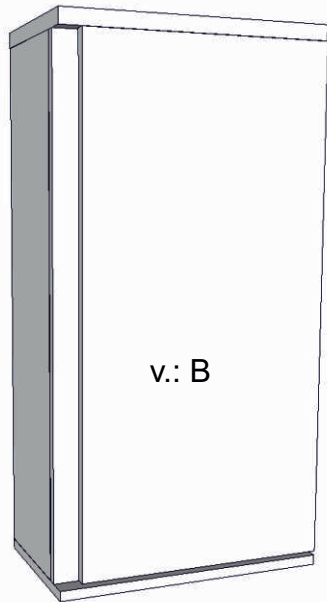

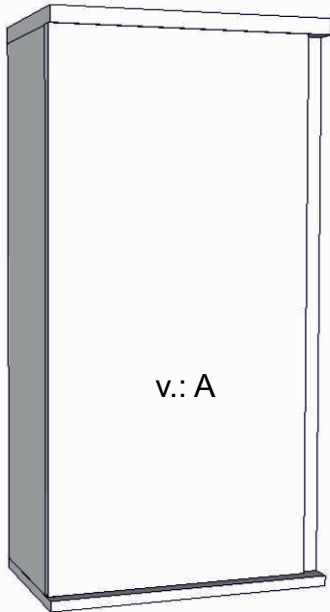





REA AMY



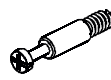

23

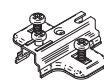
	450
	880
	250

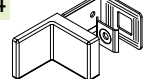

1/1

1		3		5		6		7		8		9	
kolík 8x35	11ks	tiahlo	12ks	excenter	12ks	krytka	12ks	záves naložený	2ks	podložka závesu	2ks	skrutka zh 4x16	8ks

11		17		24		24		31	
klinec 1,2x25	30ks	podperka sklo 5x5	8ks	doraz	2ks	závesný uholník+krytka	2ks	tesniaca štetina 833mm	1ks

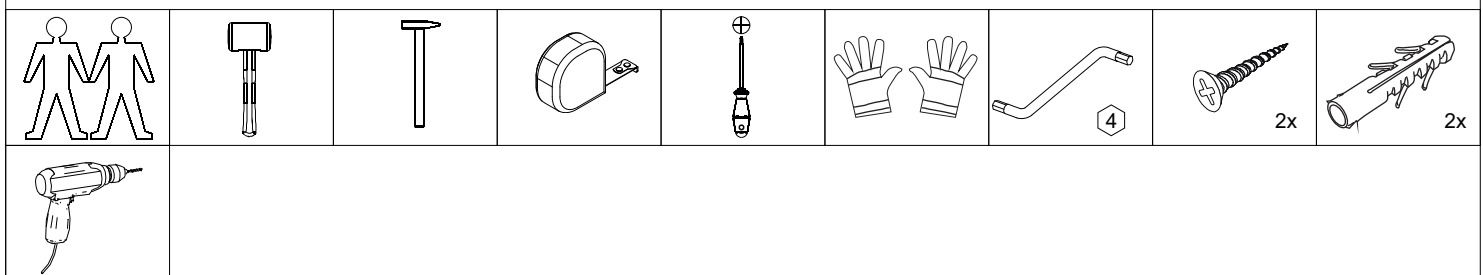

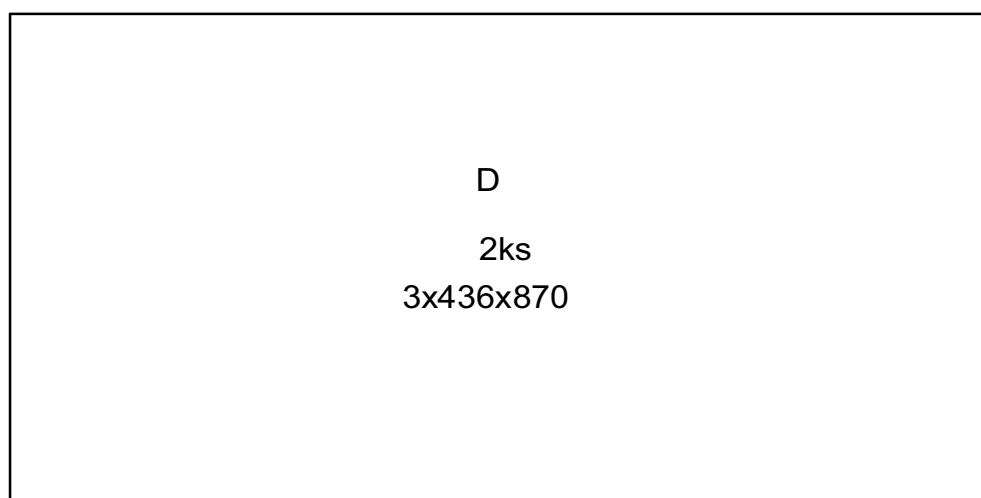
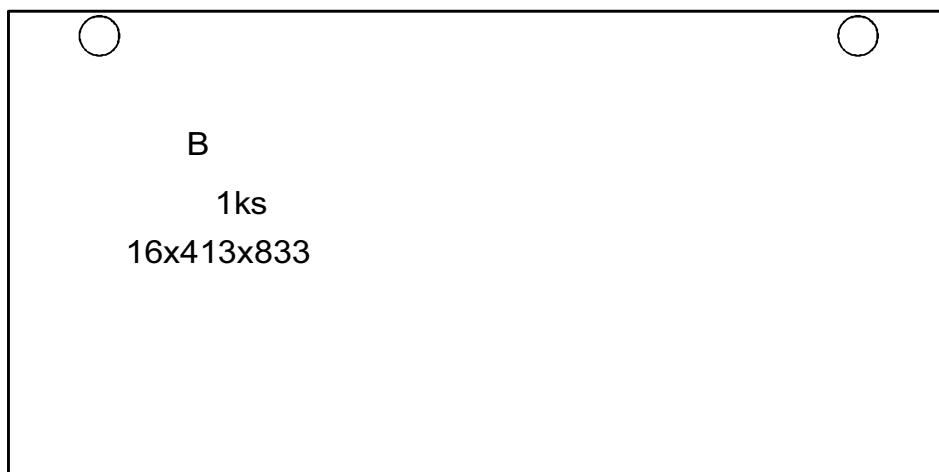
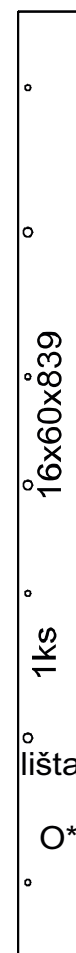
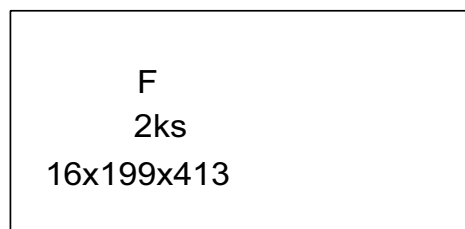
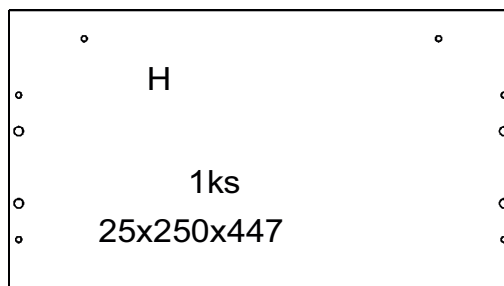
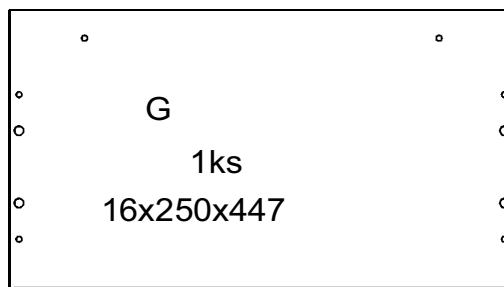
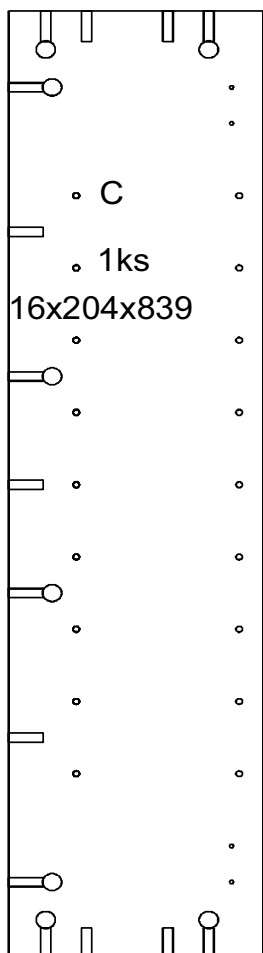
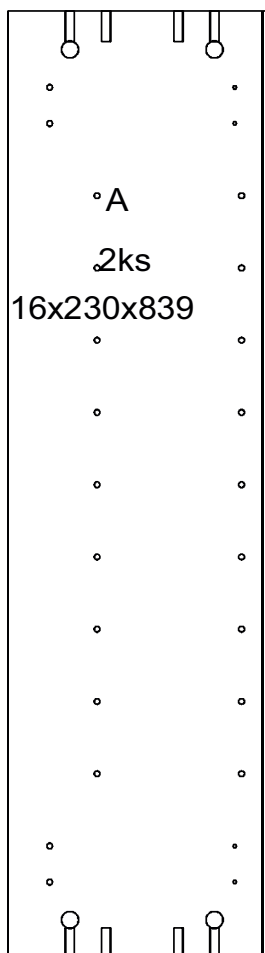

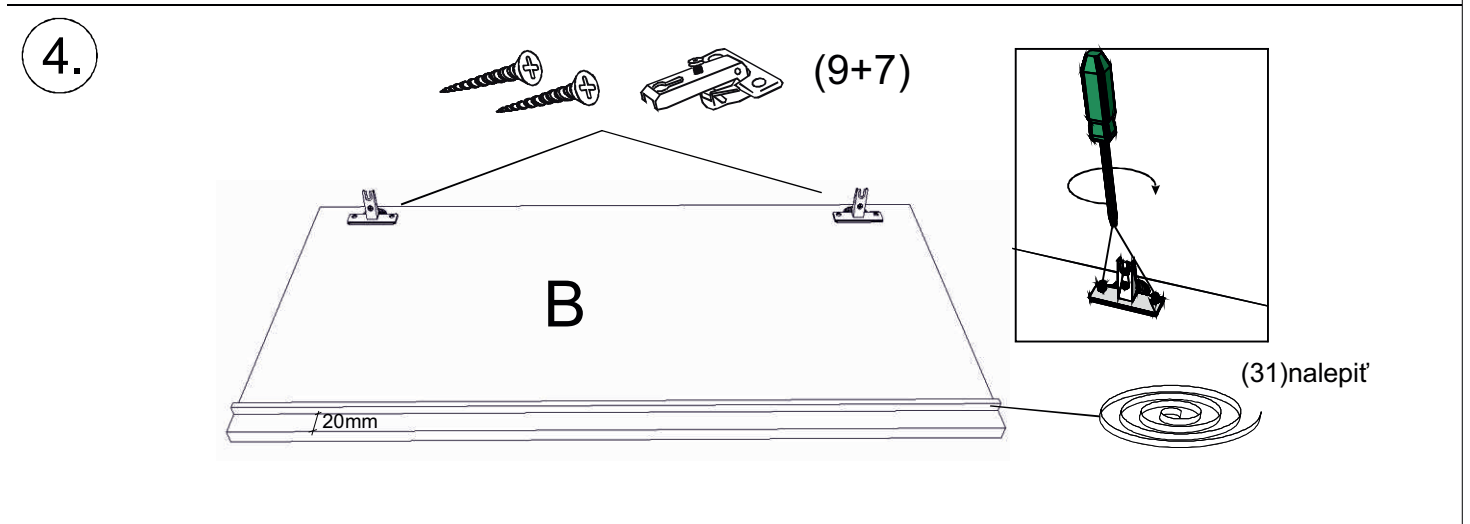
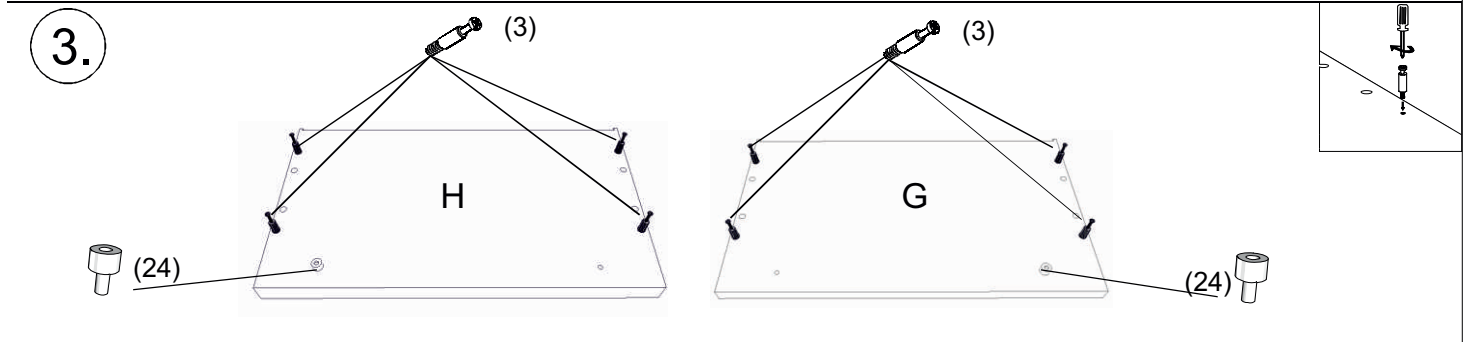
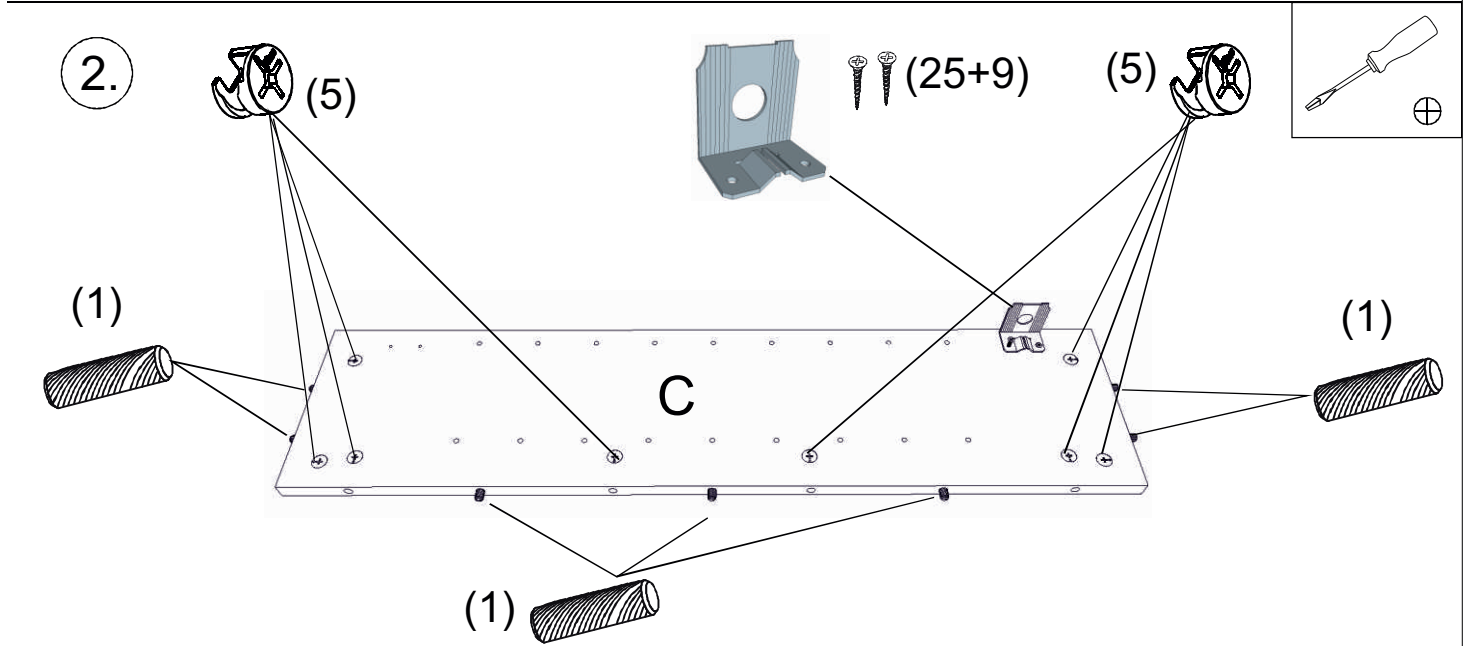
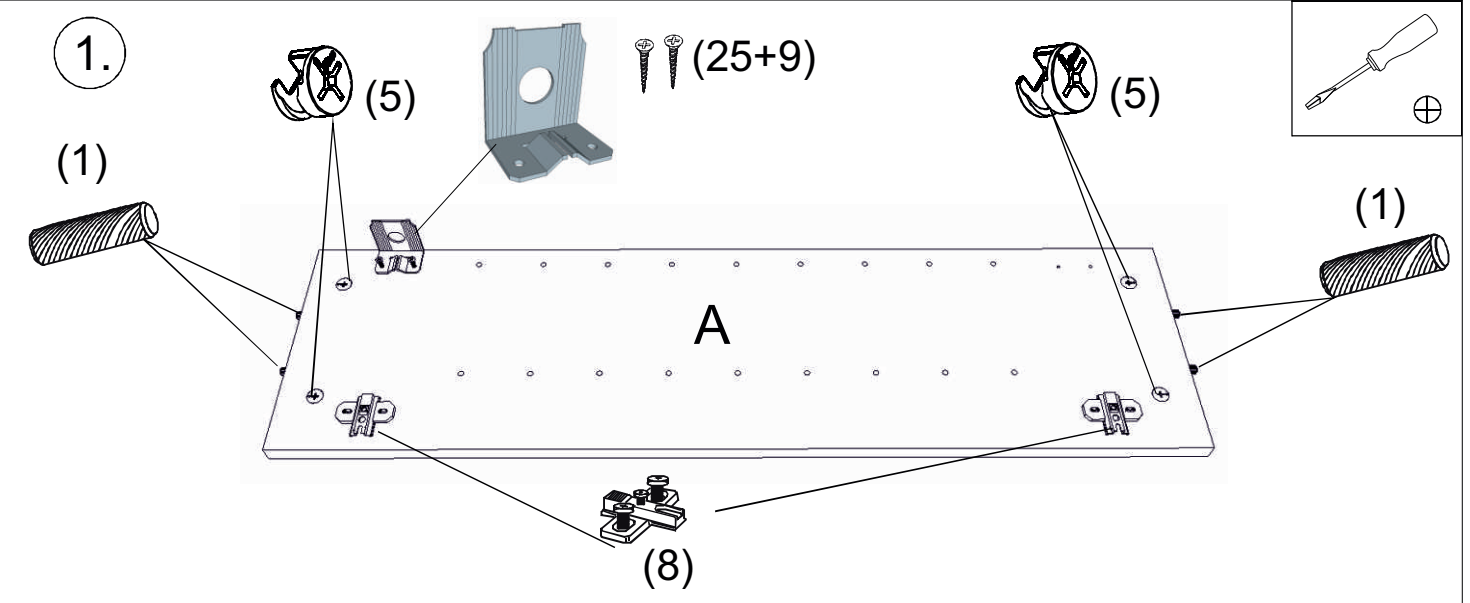

5.

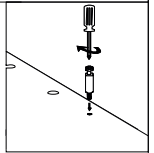
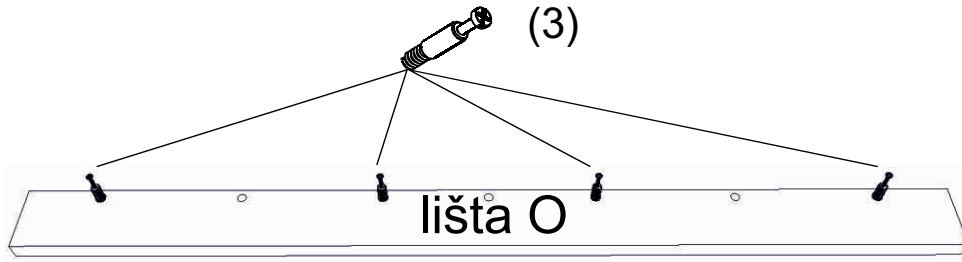

6.

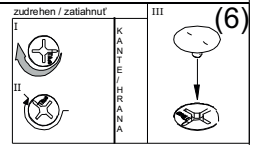
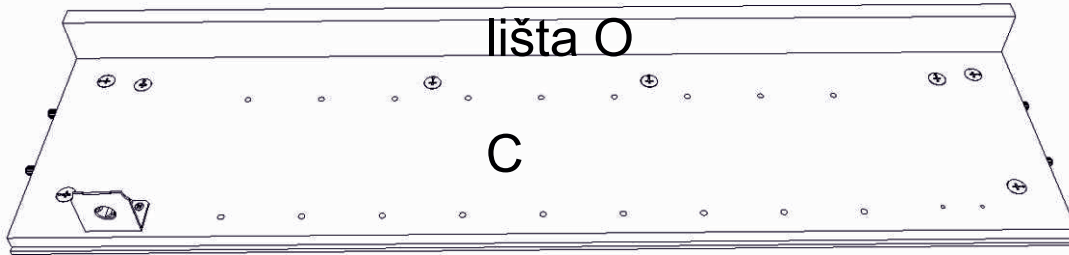

7.

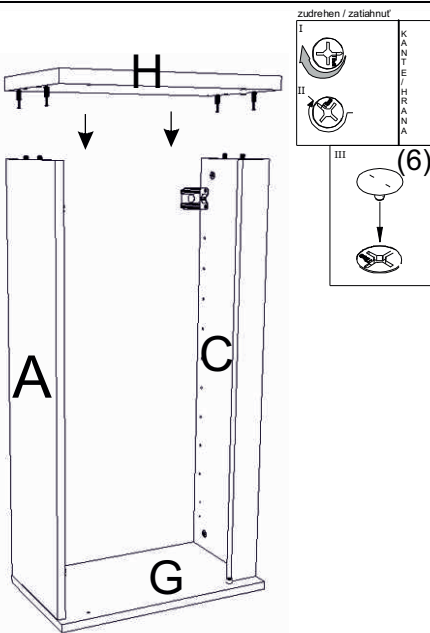

8.

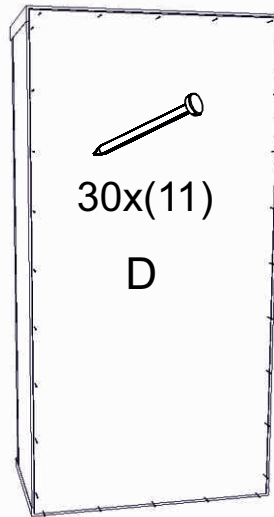

9.

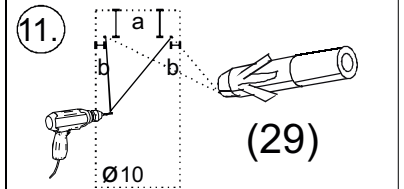
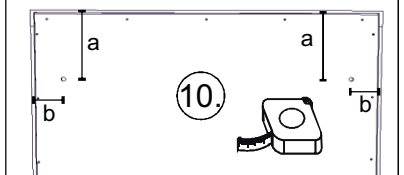
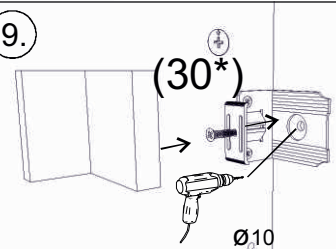

12.

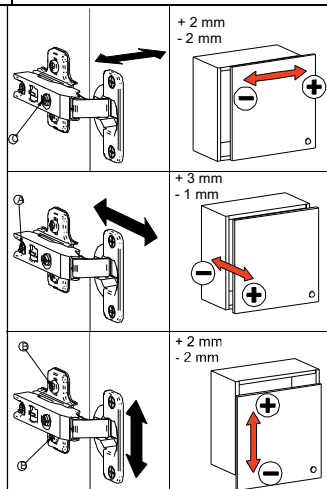
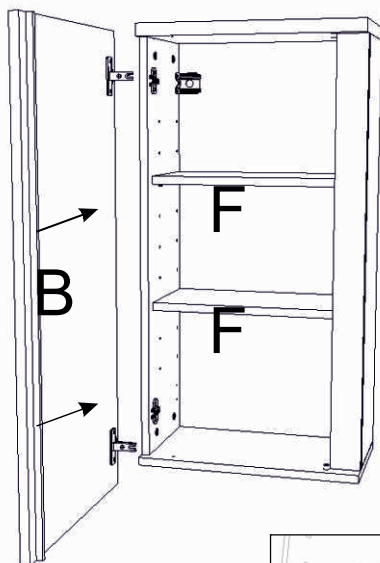

13.

