

**REA&AVA™****REA AMY  
38**

	1400
	780
	550

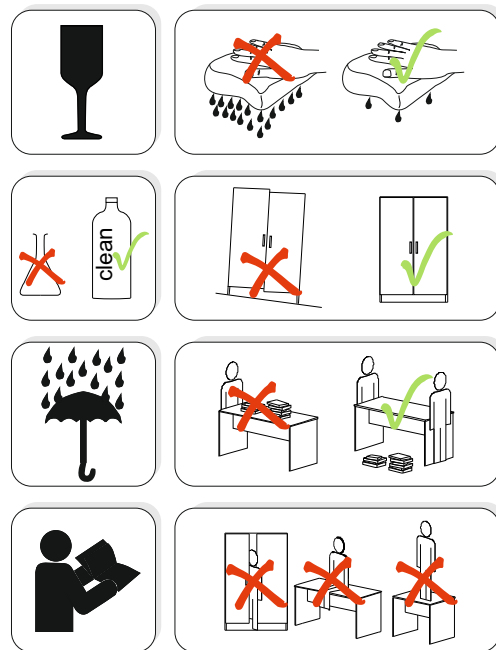
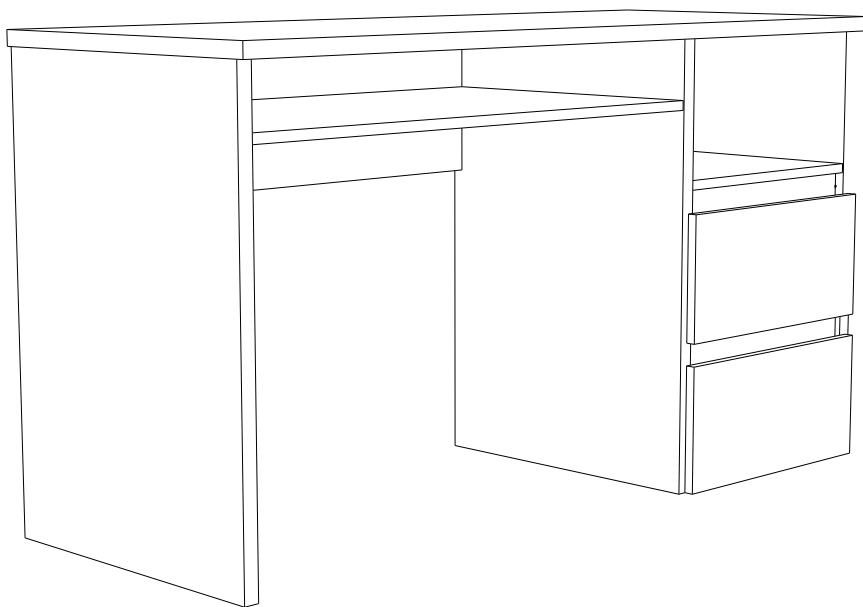

1/1

<b>1</b>		<b>3</b>		<b>4</b>		<b>5</b>		<b>6</b>		<b>9</b>		<b>10</b>	
kolík 8x35	20ks	tiahlo	41ks	skrutka zh 3,5x16	12ks	excenter	41ks	krytka	21ks	Narazací Excenter	3ks	kolík DU Tiahlo	3ks

<b>11</b>		<b>12</b>		<b>18</b>		<b>19</b>		<b>20</b>		<b>21</b>		<b>22</b>	
klinec 1,2x25	12ks	euroskrutka 6,3x11	8ks	kĺzak pasik	6ks	konfirmát 7x50	11ks	plnovýsuv 400	2x par.	skrutka zh 4x25	3ks	Pd8	3ks

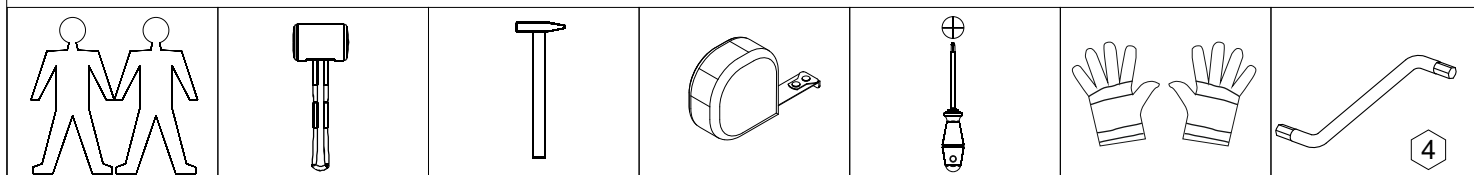

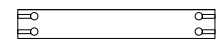
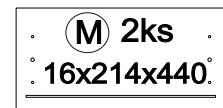
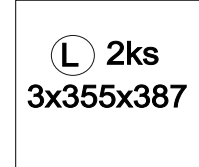
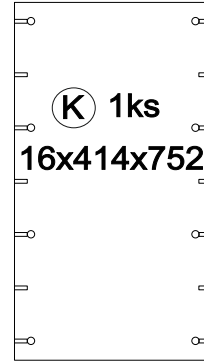
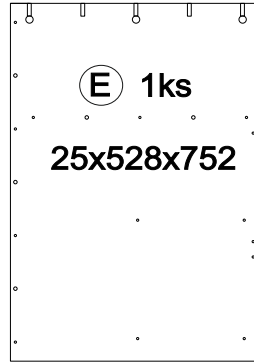
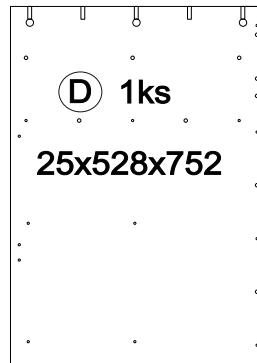
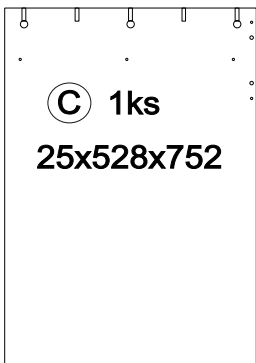
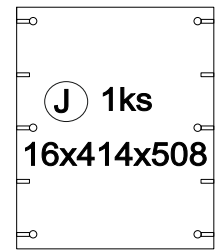
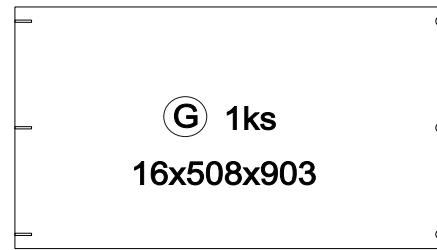
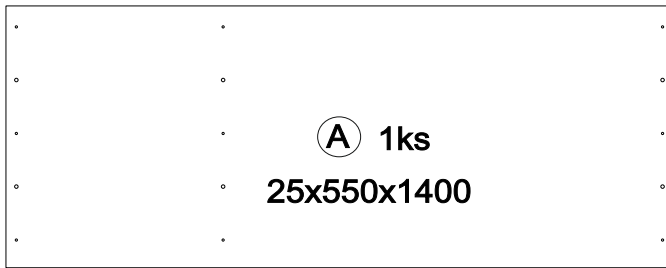

lišta H\*  
1ks -16x60x414

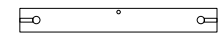

lišta B\*  
1ks -16x50x414

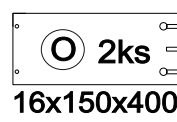
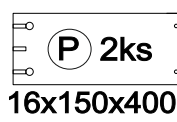
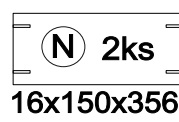
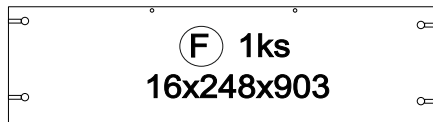

1.

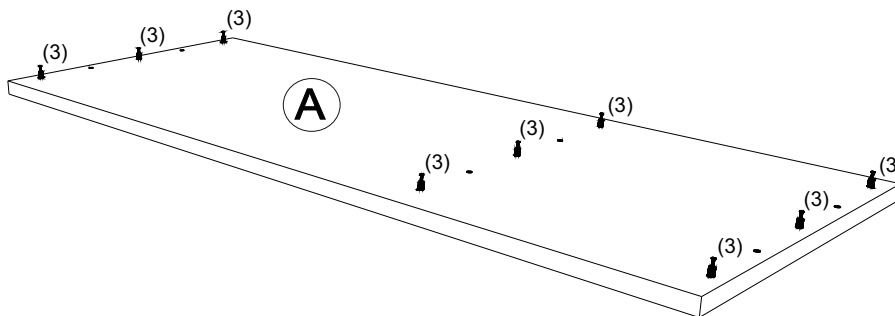
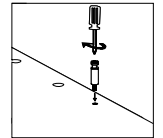
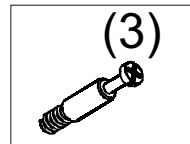

2.

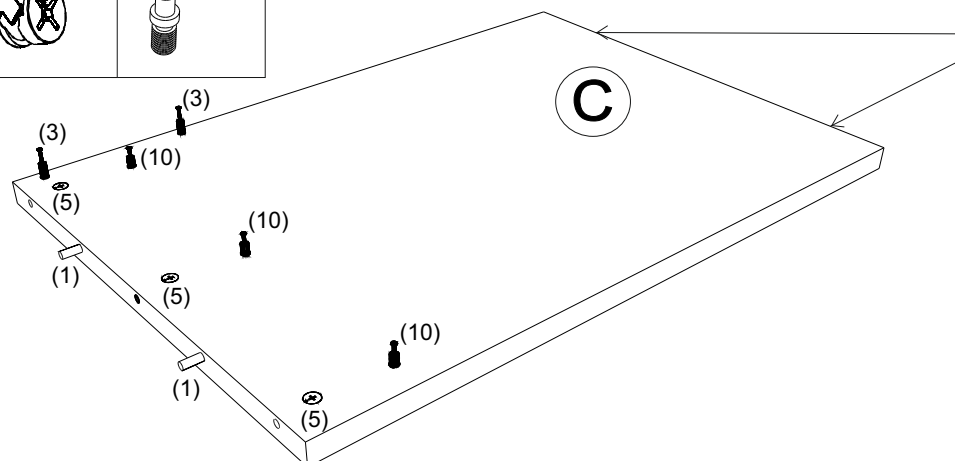
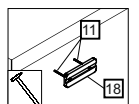
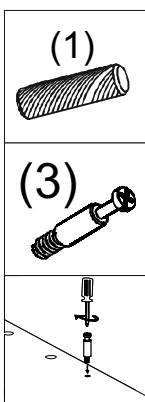
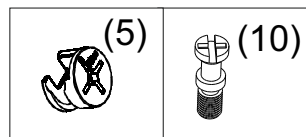

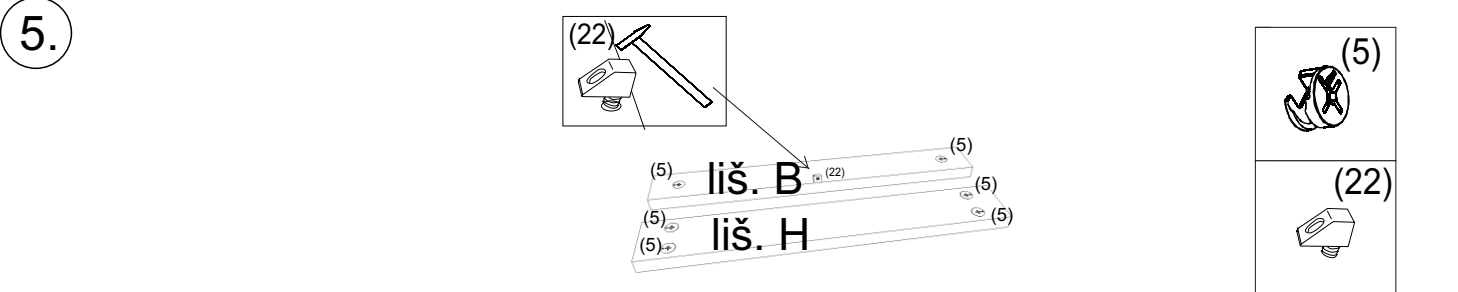
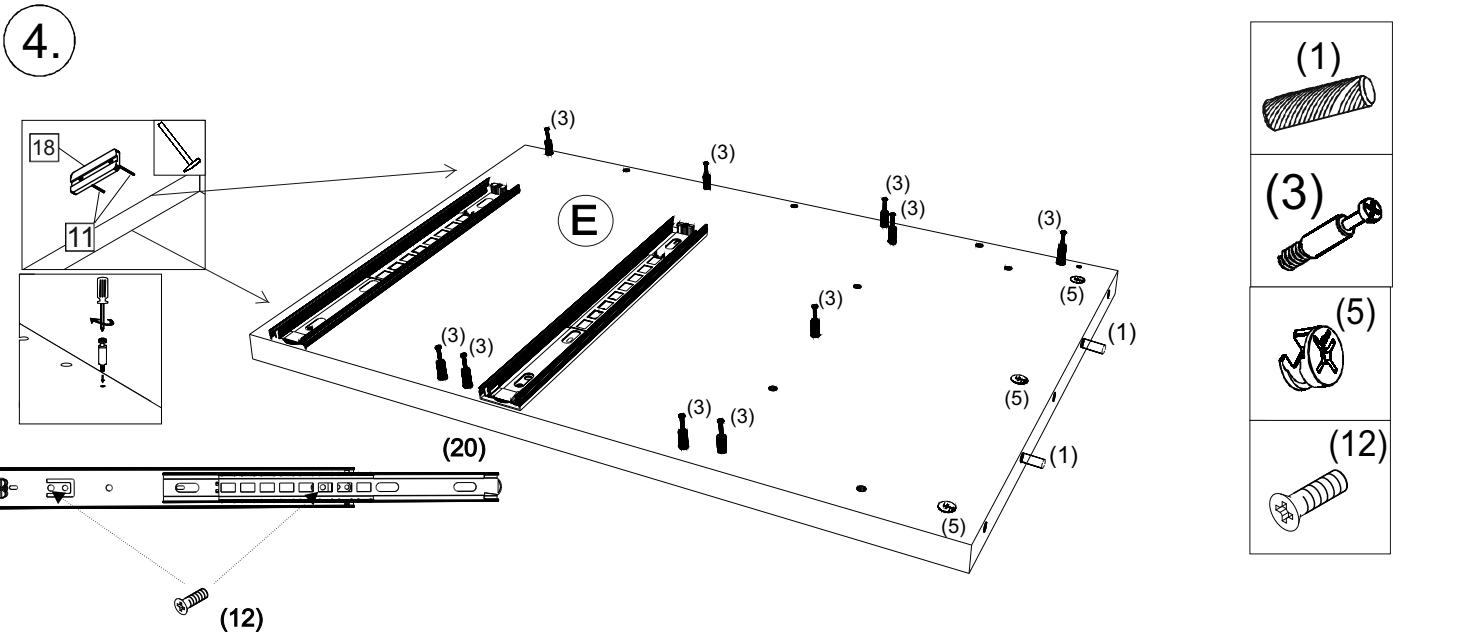
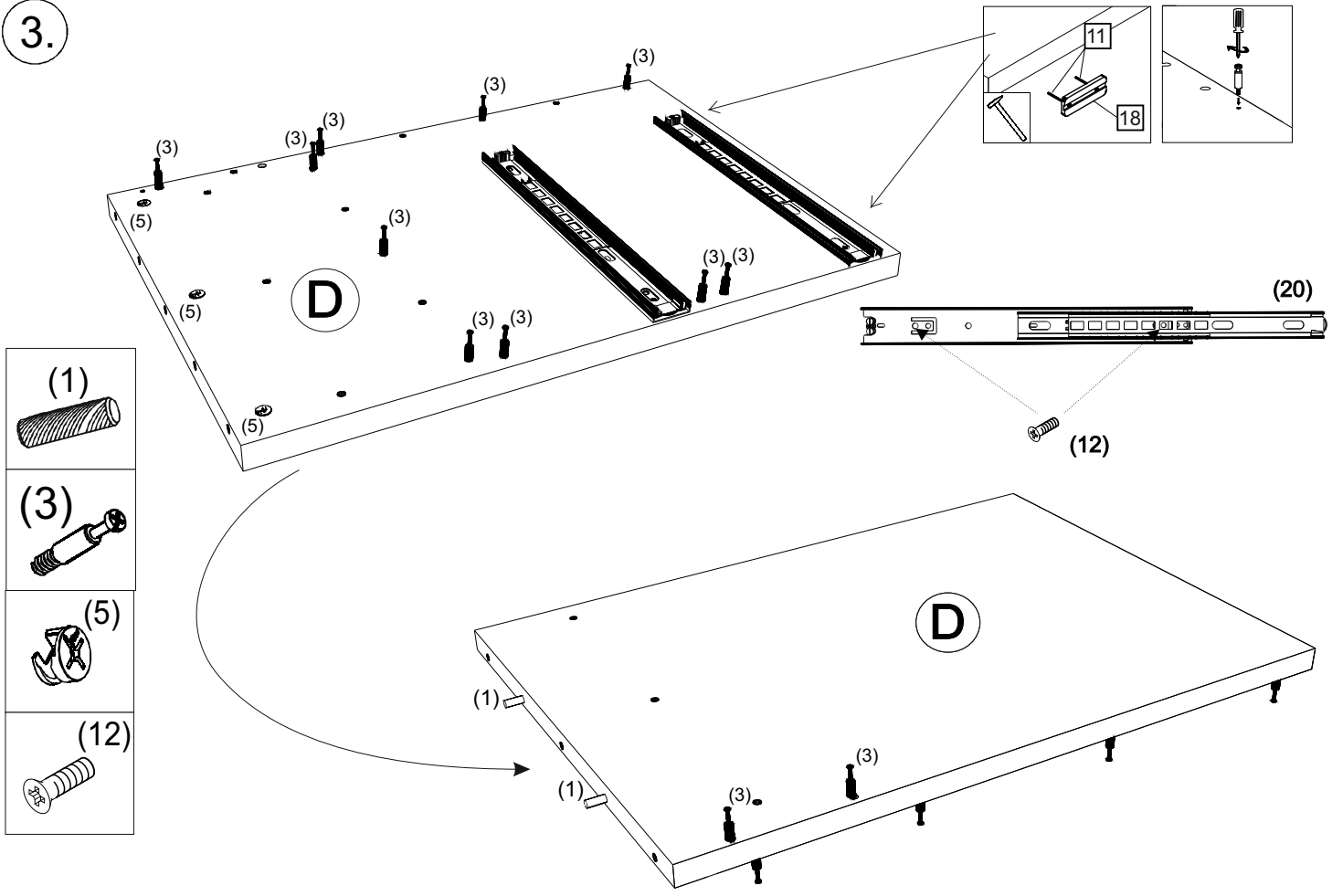

6.

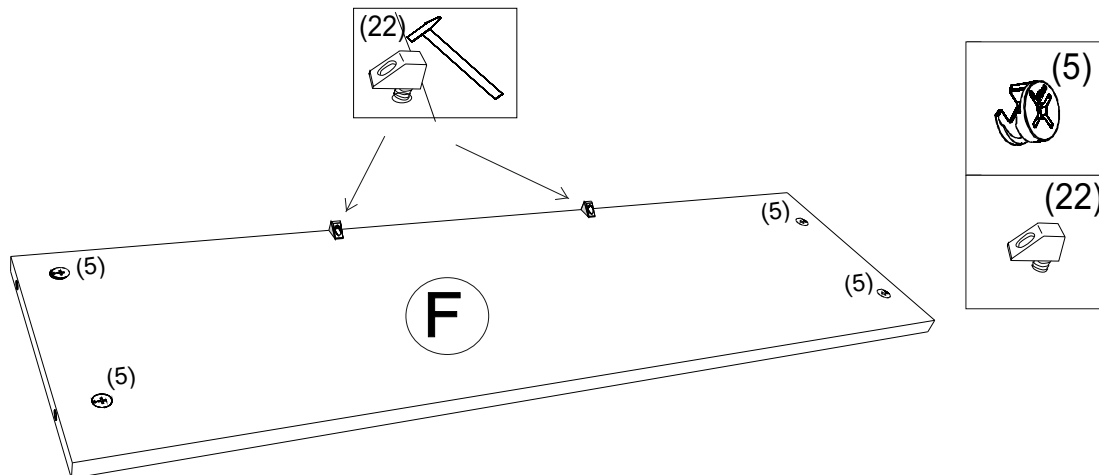

7.

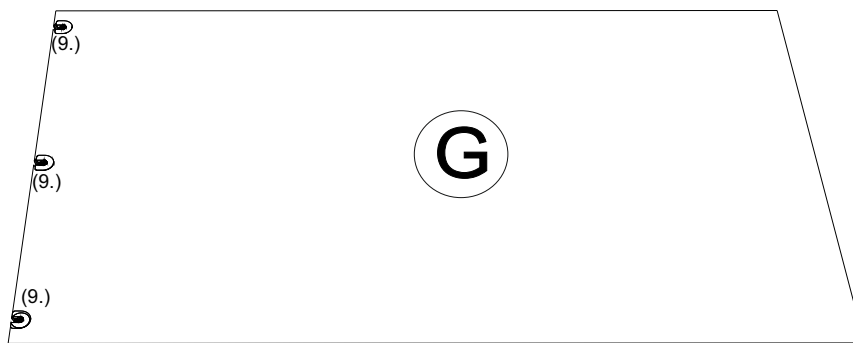
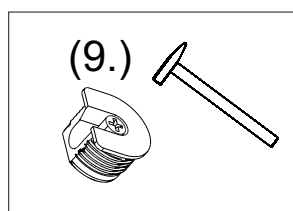

8.

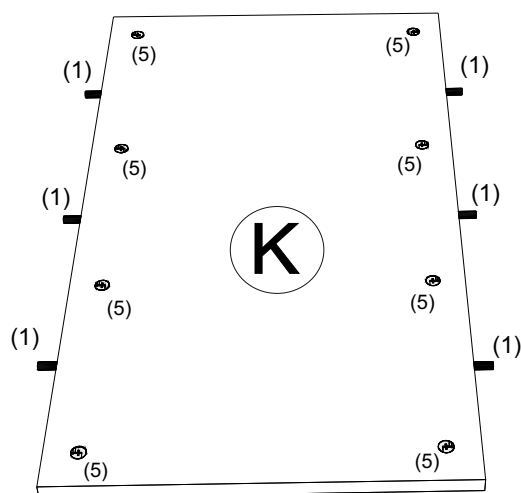
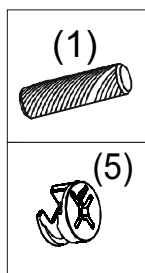
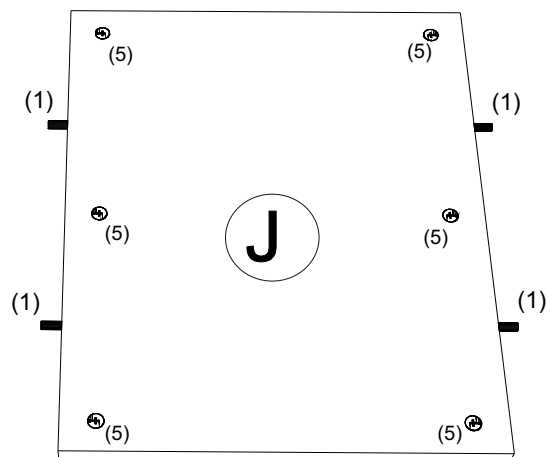

9.

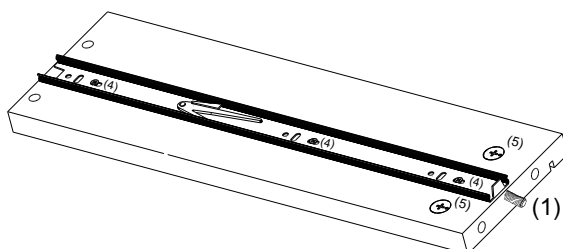

P + O

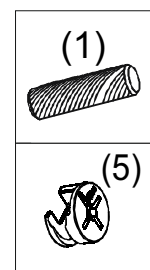
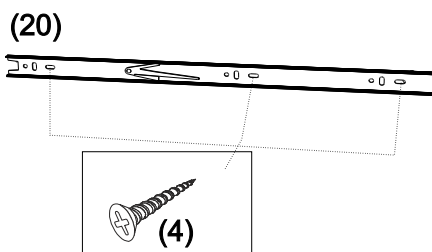

10.

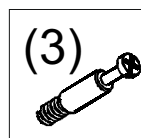

11.

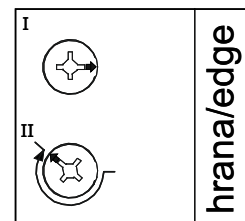
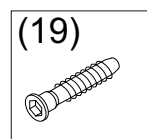
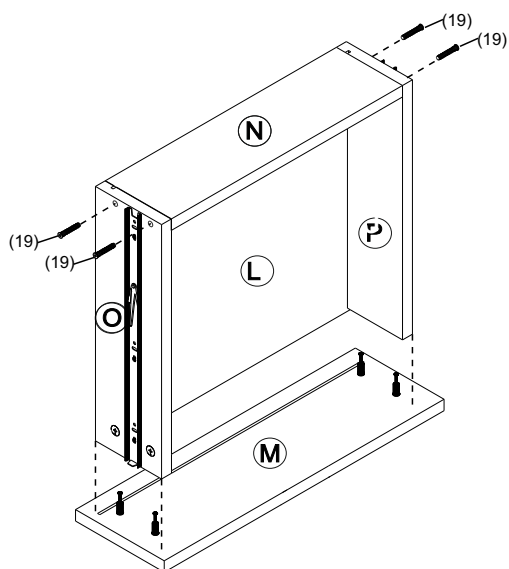

12.

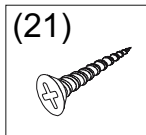
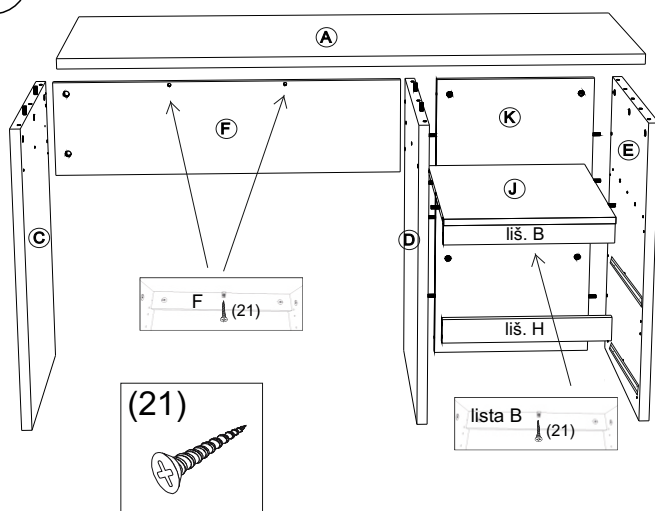

13.

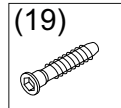
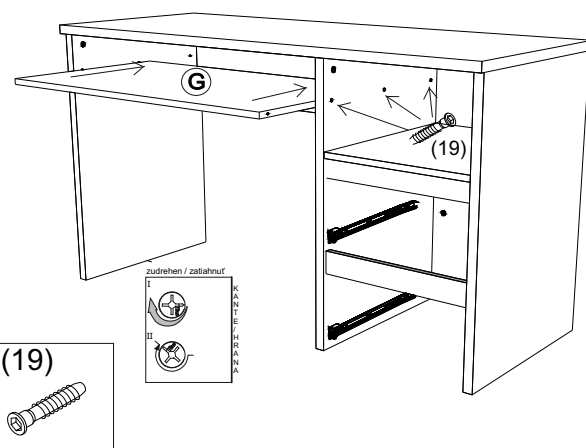

14.

